

element™

DESIGN. QUALITY. PURPOSE



ELEMENT K959 MEDICAL GRADE AIO PANEL PC



ELEMENT PRODUCT UPDATE

Element K959

The Element K959 is an elegant and slim-design all-in-one Medical Grade Panel PC that is well-suited for medical, surgical room, operating room and bedside infotainment terminal usage.

Its unique antibacterial material means that users can operate in confidence while reducing the risk of spreading infection at the bedside. Hot swappable batteries also offer great flexibility and mobility and are perfect for 24/7 use.

- 21.5" True-Flat Projective Capacitive Touch
- Intel Skylake U and Tiger Lake Processor
- Front IP65
- High grade antimicrobial plastics
- Hot swappable batteries
- On screen controls & LED work surface reading light
- On screen - quick view battery status
- Lightweight design
- Medical Certificate (EN60601-1-2:2015, ANSI/AAMI EES60601-1)



COMPREHENSIVE I/O PORTS

Element K959

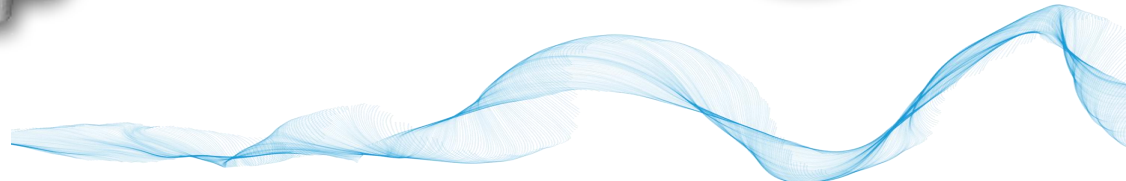

SWAPPABLE BATTERIES & LOCKABLE DESIGN



Capacitive Sensor Touch Function Keys

True-Flat Projective Capacitive Touch Screen can be frequently disinfected to reduce the risk of spreading infection at the bedside.

Four unique keys provide light, lock, Unlock and Program Function.



LED Reading
Light



Touch Screen
Lock Key



Touch Screen
Unlock Key



Programmable
Function Key

ELEMENT PRODUCT UPDATE

Element K959 Features

5MP Front Camera (Option)



21.5" True-Flat PCAP Multi-Touch
Front IP65
Full HD (1920x1080)

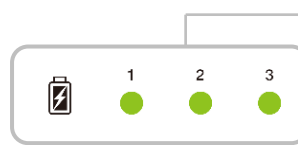

Batteries Status

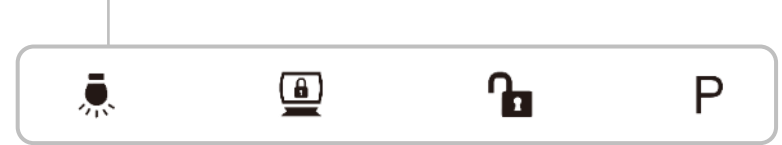

LED Reading
Light

Touch Screen
Lock Key

Touch Screen
Unlock Key

Programmable
Function Key

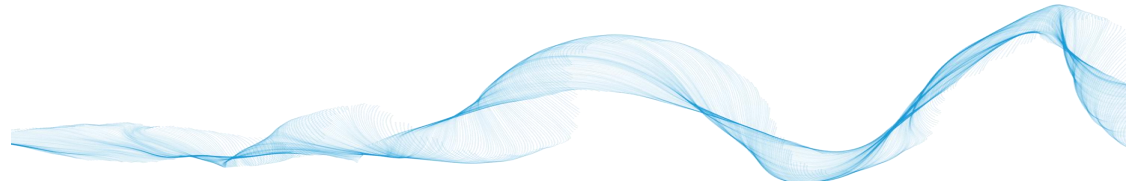

ELEMENT PRODUCT UPDATE

Element K959 Features

Anti-Bacterial Plastic Material

Card Reader
(RFID or IC Card Reader)

Fan-less Design

Power Button

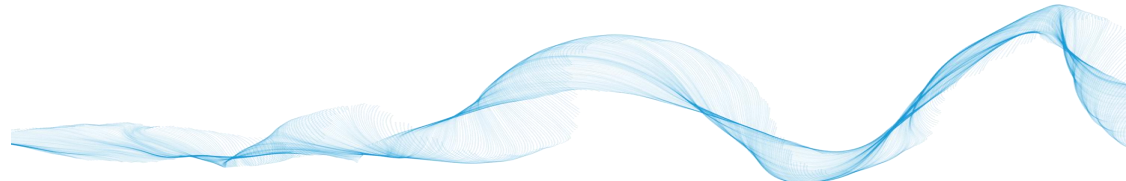

ELEMENT PRODUCT UPDATE

Element K959 Features

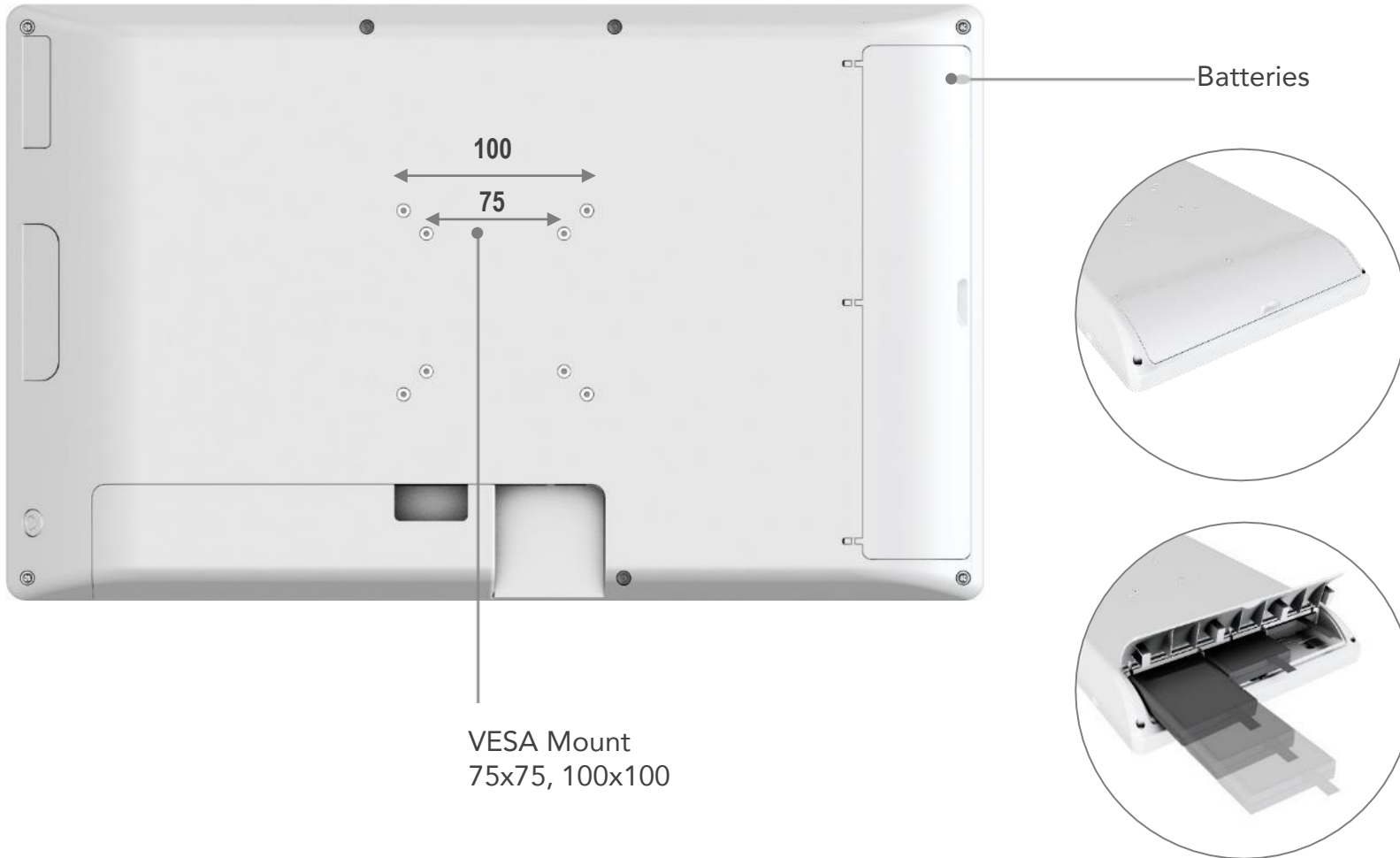

ELEMENT PRODUCT UPDATE

Element K959 Features

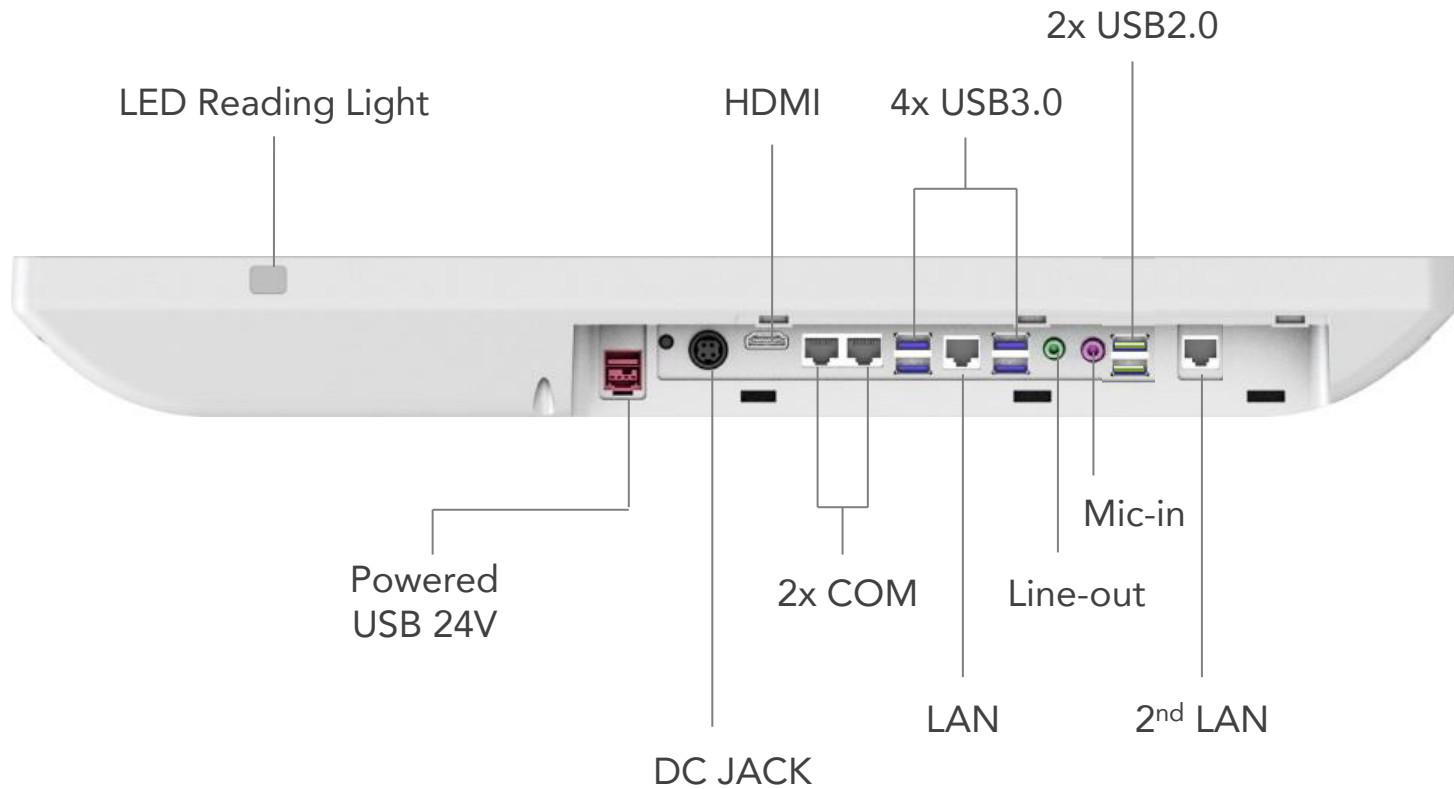

SPECIFICATIONS

Item	Parameters		
Motherboard		D87U	F87U
System	Processor	Intel SkylakeU Celeron 3955U, i3-6100U, i5-6300U @ 2.60GHz	Intel Tiger Lake i5-1135G7, i5 1145G7E
	Chipset	CPU Integrated	CPU Integrated
	System Memory	2x DDR4 2133MHz SO-DIMM (Up to 32GB; Dual-Channel)	2x DDR4 (Up to 32GB; Dual Channel)
	Storage Device	1x 2.5" SATA HDD or SSD Module	2x M.2 SSD
	Graphic Engine	Intel HD Graphics (Gen9) DX12	Intel® Iris Xe Graphics
	TPM	TPM2.0; NUVOTON 650 (Unable to support Windows 7 Series)	fTPM is standard/Hardware TPM 2.0 is optional
LCD Touch Panel	LCD Size	21.5" (16:9 Ratio)	21.5 " (16:9 Ratio)
	Brightness	250 nits	250 nits
	Resolution	1920 x 1080	1920 x 1080
	Touch Screen	PCAP Multi-Touch	True Flat PCAP Touch
Expansion	miniPCI-E Socket	1 (Half-size)	
	M.2	1x M.2 Slot half size key ID E (Non-Full Function, only 1x USB & PCI-E)	1x M.2 Slot half size key ID E
	USB	4x USB3.0, 1x 24V Powered USB	4x USB3.0, 2x USB2.0, 1x 24V Powered USB
	LAN	2x RJ48	1x RJ45
	Audio-Jack	1x Line-out, 1x Mic-in	1x Line out, 1x Mic in
	HDMI	1	1
	Serial Port	2x RJ48	2x RJ48
	DC Jack	1	1
Audio	Internal Speaker	1x 3W	1x 3W

*Product specifications and data are subject to change without notice (E&OE)

SPECIFICATIONS

Item		Parameters	
Motherboard		D87U	F87U
Peripherals	Webcam (Optional)	2MP(Optional)	5MP (Option)
	WiFi + BT (Optional)	802.11 b/g/n WLAN card + BT4.0 (option)	802.11 series + BT5.2 (option)
	LED Reading Light	1	1
	RFID	1	1 (Option)**
Power	Power Supply	180W / 19V	120W / 19V
	Wide Range Power Output	9-48V	12-48V
Battery	Battery Pack (Optional)	3x Hot Swappable Battery (Up to 12 hours, depends on loading)	3x Hot Swappable Battery (Up to 12 hours, depends on loading)
Certificate	IC Card Reader (Optional)	1 (Option)	1 (Option)**
	EMC & Safety	FCC Class A, CE Mark, LVD	FCC Class A, CE Mark, LVD
	Medical	EN 60601-1-2:2015, ANSI/AAMI ES60601-1	EN 60601-1-2:2015, ANSI/AAMI ES60601-1
Environment	Ventilation	Fanless	Fanless
	Dust & Waterproof	Front IP65, IPX1 (Enclosure)	Front IP65
	Operating Temperature	0°C ~ 35°C (32°F ~ 95°F) (Still Air)	0°C ~ 35°C (32°F ~ 95°F) (Still Air)
	Storage Temperature	-20°C ~ 60°C (-4°F ~ 140°F)	-20°C ~ 60°C (-4°F ~ 140°F)
	Humidity	10% ~ 90% RH non-condensing	10% ~ 90% RH non-condensing

*Product specifications and data are subject to change without notice (E&OE)

**Either RFID or IC Card Reader, not both

SPECIFICATIONS

Items	Parameters	
Motherboard	D87U	F87U
Dimensions (WxDxH)	533 x 59 x 325 mm (17.4" x 1.9" x 10.7")	533 x 59 x 325 mm (17.4" x 1.9" x 10.7")
Weight	5.5 kg (12.2 lbs); With All Batteries: 7kg (15.4 lbs)	5.5 kg (12.2 lbs); With All Batteries: 7kg (15.4 lbs)
Mounting	VESA Mount 75mm x 75mm, 100mm x 100mm Standard	VESA Mount 75mm x 75mm, 100mm x 100mm Standard
OS Supported	Windows 10 IOT LTSB 64 Bit, Linux	Windows 11 IOT 64 Bit, Windows 10 IOT 64 Bit, Linux
Associated Accessories	3 Bay Battery Charger - ELEMENT K959 DOCK DESK BATTERY CHARGER 3-BAY (TTFLK959003)	3 Bay Battery Charger - ELEMENT K959 DOCK DESK BATTERY CHARGER 3-BAY (TTFLK959003)
	Additional Batteries - ELEMENT K959 BATTERY HOT SWAPPABLE 3/PK (TTFLK959002)	Additional Batteries - ELEMENT K959 BATTERY HOT SWAPPABLE 3/PK (TTFLK959002)
Warranty	36 months (Terminal Only)	

*Product specifications and data are subject to change without notice (E&OE)

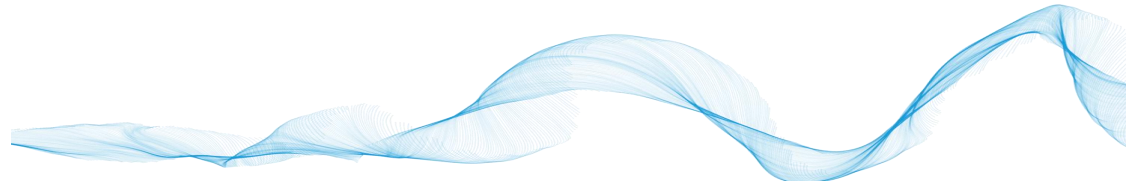

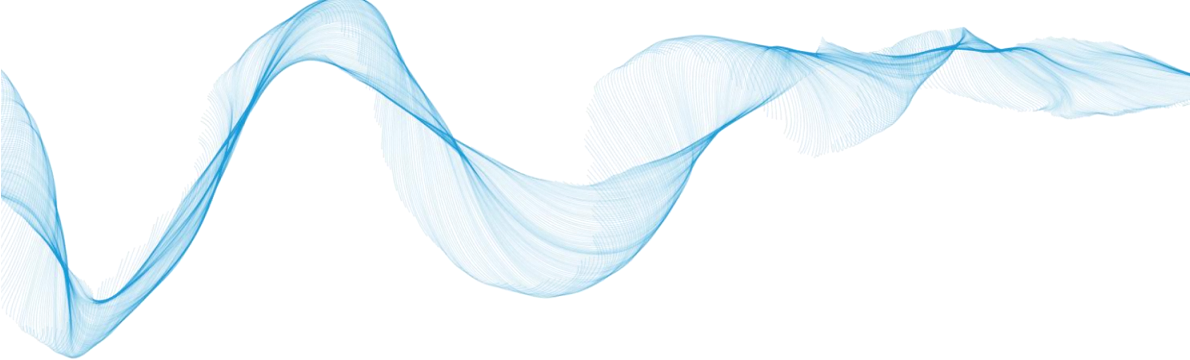

elementTM

www.elementpos.co