

# PC45 SERIES DESKTOP PRINTER

Configuration Guide



**PC45d** HEALTHCARE  
DIRECT  
THERMAL

**PC45t**  
THERMAL  
TRANSFER

**PC45d**  
DIRECT  
THERMAL

THE  
FUTURE  
IS  
WHAT  
WE  
MAKE IT

**Honeywell**

# TABLE OF CONTENTS

- 1** **TABLE OF CONTENTS**
- 2** **PC45d PRINTING OPTIONS**
- 3** **PC45d MEDIA SPECIFICATIONS**
- 5** **PC45d FEATURE OVERVIEW**
  - TEAR OFF
    - FULL TOUCH DISPLAY - DIRECT THERMAL
    - FULL TOUCH DISPLAY - DIRECT THERMAL - RFID (EU)
    - FULL TOUCH DISPLAY - DIRECT THERMAL - RFID (NA)
    - FULL TOUCH DISPLAY - DIRECT THERMAL - WI-FI/ BLUETOOTH (ROW)
    - FULL TOUCH DISPLAY - DIRECT THERMAL - WI-FI/ BLUETOOTH (NA)
- 11** **PC45d HEALTHCARE FEATURE OVERVIEW**
  - TEAR OFF
    - FULL TOUCH DISPLAY - DIRECT THERMAL
    - FULL TOUCH DISPLAY - DIRECT THERMAL - WI-FI/ BLUETOOTH (NA)
- 13** **PC45d LINERLESS FEATURE OVERVIEW**
  - TEAR OFF
    - FULL TOUCH DISPLAY - DIRECT THERMAL
    - FULL TOUCH DISPLAY - DIRECT THERMAL - RFID (NA) - WI-FI/ BLUETOOTH (NA)
- 15** **PC45d CONFIGURATION MAP**
  - DESKTOP PRINTER
- 16** **PC45t PRINTING OPTIONS**
- 17** **PC45t MEDIA SPECIFICATIONS**
- 19** **PC45t FEATURE OVERVIEW**
  - TEAR OFF
    - FULL TOUCH DISPLAY - THERMAL TRANSFER
    - FULL TOUCH DISPLAY - THERMAL TRANSFER - RFID (EU) - WI-FI/ BLUETOOTH (ROW)
    - FULL TOUCH DISPLAY - THERMAL TRANSFER - RFID (NA) - WI-FI/ BLUETOOTH (NA)
    - FULL TOUCH DISPLAY - THERMAL TRANSFER - WI-FI/ BLUETOOTH (ROW)
    - FULL TOUCH DISPLAY - THERMAL TRANSFER - WI-FI/ BLUETOOTH (NA)
- 25** **PC45t CONFIGURATION MAP**
  - DESKTOP PRINTER
- 26** **HONEYWELL EDGE SERVICES**
  - GOLD REPAIR SERVICES - 3 YEAR
  - PLATINUM REPAIR SERVICES - 3 YEAR
  - GOLD REPAIR SERVICES - 5 YEAR
  - PLATINUM REPAIR SERVICES - 5 YEAR
  - PC45d / PC45t - REPAIR SERVICES COVERAGE
- 29** **ACCESSORIES**
  - PC45d / PC45t - WI-FI AND BLUETOOTH CARD
  - PC45d / PC45t - WWAN 4G LTE - CELLULAR MODEM
- 31** **ACCESSORIES**
  - PC45d CUTTERS
  - PC45t CUTTER
  - PC45d SELF STRIP
  - PC45t SELF STRIP
  - EXTERNAL MEDIA HANGER
  - CONSUMABLES AND CABLES
- 36** **MISCELLANEOUS**
  - POWER SUPPLY
  - AC CORDS
- 37** **APPENDIX**
  - PC45 VS PC43 ACCESSORIES
  - FRONT DISPLAY - COMPARE PC45 TO PC43
  - MEDIA COMPARTMENT - COMPARE PC45t TO PC43t
  - CONNECTIVITY - COMPARE PC45 TO PC43

# PC45d PRINTING OPTIONS



## Tear Off

Most commonly used, print any number of labels and simply tear the labels off from the printer at the end of the print job.

This method of printing is available on any PC45d configuration.



## Linerless

Unlike standard labels, linerless labels do not have a liner to peel away and separate the adhesive from labels underneath it on the roll.

PC45D2xxxxxxx    PC45d Linerless Option

Linerless PC45d printers include a linerless platen roller:  
205-187-003    PC45d Linerless Platen Roller



## Linerless Cutter

A linerless cutter is for use exclusively with linerless media, typically used with continuous linerless media.

205-187-004    PC45d Linerless Cutter + LTS Kit



## Peel & Present (Self-Strip)

Self-Strip prints and presents only one label at a time already peeled from the backing strip/ liner, the next label will only be printed once the original label is removed from the media path.

205-187-001    PC45d Self-Strip + LTS Kit  
205-189-001    PC45d Healthcare Self-Strip + LTS Kit



## Cutter

A cutter can be added to any configuration of PC45d, simply cutting between labels, or at intervals on continuous media. This method of printing is available on any PC45d configuration.

205-187-006    PC45d Cutter



## External Media Holder

Provides support for media up to 21.27cm (8.375 in) rolls of media for the PC45d.

205-190-005    External Media Holder

ID = Inside Diameter  
OD = Outside Diameter

# PC45d MEDIA

## Specifications

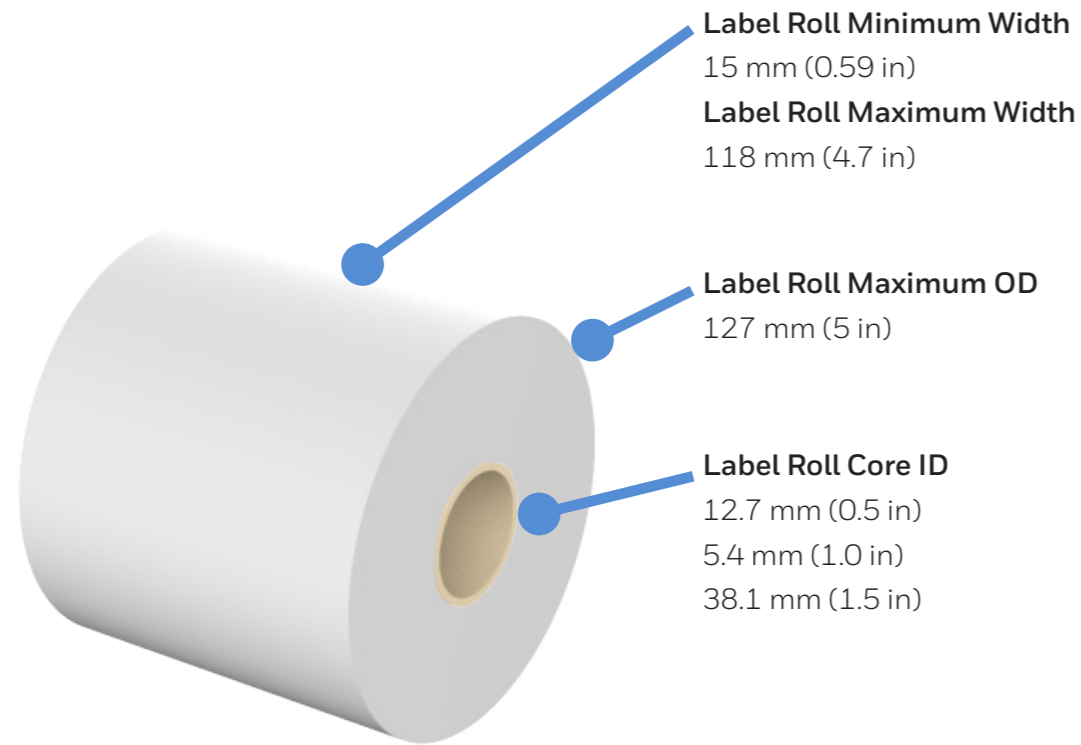

**Label Roll Minimum Width**  
15 mm (0.59 in)  
**Label Roll Maximum Width**  
118 mm (4.7 in)

**Label Roll Maximum OD**  
127 mm (5 in)

**Label Roll Core ID**  
12.7 mm (0.5 in)  
5.4 mm (1.0 in)  
38.1 mm (1.5 in)

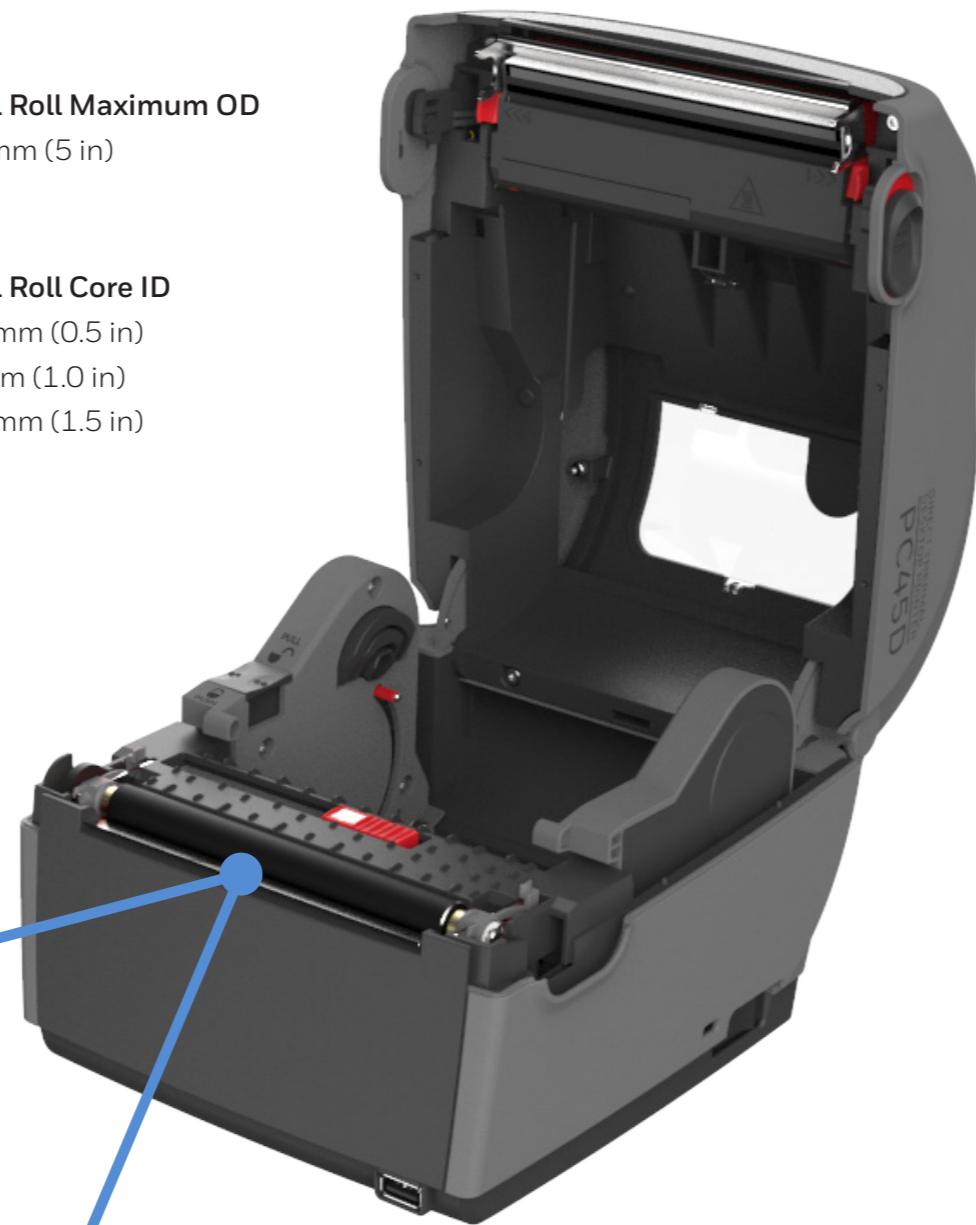

**Minimum Label Length**

Tear Off	6.35 mm (0.25 in)
Peel-Off Kit	12.5 mm (0.49 in)
Cutter (Full Cut)	12.5 mm (0.49 in)
Cutter (Partial Cut)	25 mm (1.0 in)
Cutter (Linerless)	25 mm (1.0 in)
RFID	15 mm (0.6 in)

**Maximum Print Width**  
203 dpi: 104 mm (4.1 in)  
300 dpi: 106 mm (4.2 in)

ID = Inside Diameter  
OD = Outside Diameter

# PC45d MEDIA

## Specifications



Media Hanger + Label Roll Core 38 mm (1.5 in) ID  
Shown with Label Roll 127 mm (5 in) OD  
Typical length of material with typical thickness of labels ~ 72 m



Adjustable Media Sensor

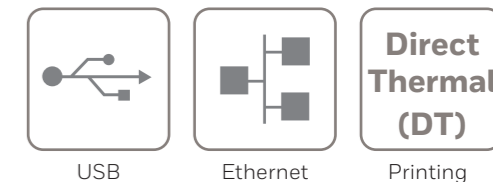

# PC45d FEATURE OVERVIEW

**Tear Off - Full Touch Display - Direct Thermal**



## PC45d - Full Touch - Direct Thermal - 203 DPI

**PC45D00000200**

PC45d, 4-inch, Full Touch 3.5-inch LCD, Ethernet, Latin Font, Real Time Clock (RTC), Direct Thermal (DT) 203 DPI, includes Power Supply, No Power Cord

### Included in the box:

- PC45d
- PC45 Regulatory Sheet (PC45-ML-RS-01)
- Power Supply (203-186-200)
- USB Cable (321-576-004)



- No Power Cord

### Honeywell Repair Services

SVCPC45-SG3N

PC45, Edge Service, Gold Maintenance Contract, 3 Year, New Contract

**ADD** SVCPRINTHEAD-PRN3

AddOn, Edge Service, Printhead Refresh Service, 203 or 300 DPI, 3-Year Contract

**ADD** SVCACC-PRN3

AddOn, Edge Service, Accessory Service, Printer, 3 Year

Note: Not all printer combinations are available in every region. Check your local Price Book to see which part numbers are available for sale.

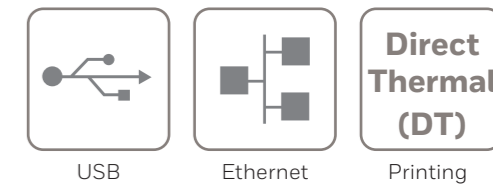

# PC45d FEATURE OVERVIEW

## Tear Off - Full Touch Display - Direct Thermal



### PC45d - Full Touch - Direct Thermal - 203 DPI

**PC45D00000201**

PC45d, 4-inch, Full Touch 3.5-inch LCD, Ethernet, Latin Font, Real Time Clock (RTC), Direct Thermal (DT) 203 DPI, includes Power Supply, US Power Cord

#### Included in the box:

- PC45d
- PC45 Regulatory Sheet (PC45-ML-RS-01)
- Power Supply (203-186-200)
- USB Cable (321-576-004)



- US Power Cord

Note: Not all printer combinations are available in every region. Check your local Price Book to see which part numbers are available for sale.

#### Honeywell Repair Services

SVCPC45-SG3N

PC45, Edge Service, Gold Maintenance Contract, 3 Year, New Contract

**ADD** SVCPRINTHEAD-PRN3

AddOn, Edge Service, Printhead Refresh Service, 203 or 300 DPI, 3-Year Contract

**ADD** SVCACC-PRN3

AddOn, Edge Service, Accessory Service, Printer, 3 Year

# PC45d FEATURE OVERVIEW

**Tear Off - Full Touch Display - Direct Thermal - RFID (EU)**

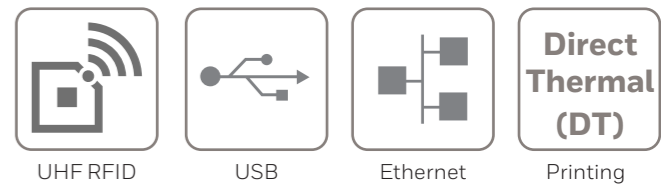

**PC45d - Full Touch - UHF RFID - Direct Thermal - 203 DPI**

**PC45D00EU00200**

PC45d, 4-inch, Full Touch 3.5-inch LCD, Ethernet, Latin Font, Real Time Clock (RTC), UHF RFID Europe/ROW (EU), Direct Thermal (DT) 203 DPI, includes Power Supply, No Power Cord

**Included in the box:**

- PC45d
- PC45 Regulatory Sheet (PC45-ML-RS-01)
- Power Supply (203-186-200)
- USB Cable (321-576-004)



- No Power Cord

**Honeywell Repair Services**

SVCPC45-SG3N

PC45, Edge Service, Gold Maintenance Contract, 3 Year, New Contract

**ADD** SVCPRINTHEAD-PRN3

AddOn, Edge Service, Printhead Refresh Service, 203 or 300 DPI, 3-Year Contract

**ADD** SVCACC-PRN3

AddOn, Edge Service, Accessory Service, Printer, 3 Year

Note: Not all printer combinations are available in every region. Check your local Price Book to see which part numbers are available for sale.

# PC45d FEATURE OVERVIEW

**Tear Off - Full Touch Display - Direct Thermal - RFID (NA)**

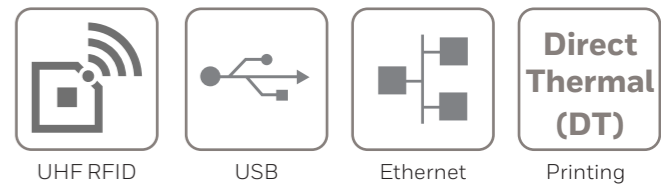

**PC45d - Full Touch - UHF RFID - Direct Thermal - 203 DPI**

**PC45D00NA00201**

PC45d, 4-inch, Full Touch 3.5-inch LCD, Ethernet, Latin Font, Real Time Clock (RTC), UHF RFID North America (NA), Direct Thermal (DT) 203 DPI, includes Power Supply, US Power Cord

**Included in the box:**

- PC45d
- PC45 Regulatory Sheet (PC45-ML-RS-01)
- Power Supply (203-186-200)
- USB Cable (321-576-004)



- US Power Cord

**Honeywell Repair Services**

SVCPC45-SG3N

PC45, Edge Service, Gold Maintenance Contract, 3 Year, New Contract

**ADD** SVCPRINTHEAD-PRN3

AddOn, Edge Service, Printhead Refresh Service, 203 or 300 DPI, 3-Year Contract

**ADD** SVCACC-PRN3

AddOn, Edge Service, Accessory Service, Printer, 3 Year

Note: Not all printer combinations are available in every region. Check your local Price Book to see which part numbers are available for sale.

# PC45d FEATURE OVERVIEW

**Tear Off - Full Touch Display - Direct Thermal -  
Wi-Fi/ Bluetooth (ROW)**

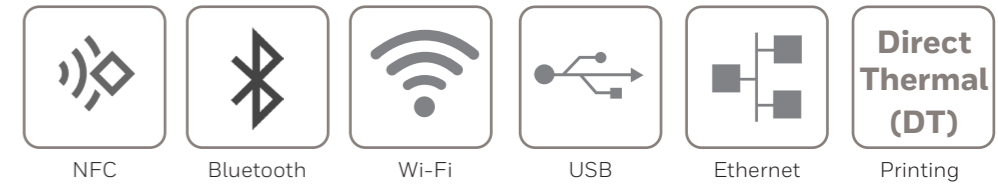

**PC45d - Full Touch - Wi-Fi/ Bluetooth (ROW) - Direct Thermal - 203 DPI**

**PC45D020000200**

PC45d, 4-inch, Full Touch 3.5-inch LCD, Ethernet, Bluetooth V5.2, Wi-Fi 6 Rest of World (ROW) IEEE 802.11 a/b/g/n/ac/ax, Passive NFC tag for Tap and Pair, Latin Font, Real Time Clock (RTC), Direct Thermal (DT) 203 DPI, includes Power Supply, No Power Cord

**Included in the box:**

- PC45d
- PC45 Regulatory Sheet (PC45-ML-RS-01)
- Power Supply (203-186-200)
- USB Cable (321-576-004)



- No Power Cord

Note: Not all printer combinations are available in every region. Check your local Price Book to see which part numbers are available for sale.

**Honeywell Repair Services**

SVCPC45-SG3N

PC45, Edge Service, Gold Maintenance Contract, 3 Year, New Contract

**ADD** SVCPRINTHEAD-PRN3

AddOn, Edge Service, Printhead Refresh Service, 203 or 300 DPI, 3-Year Contract

**ADD** SVCACC-PRN3

AddOn, Edge Service, Accessory Service, Printer, 3 Year

# PC45d FEATURE OVERVIEW

**Tear Off - Full Touch Display - Direct Thermal -  
Wi-Fi/ Bluetooth (NA)**

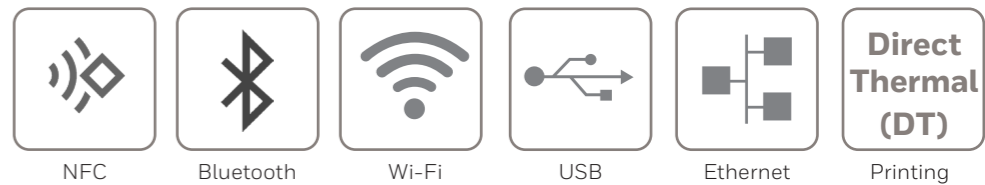

**PC45d - Full Touch - Wi-Fi/ Bluetooth (NA) - Direct Thermal - 203 DPI**

**PC45D010000201**

PC45d, 4-inch, Full Touch 3.5-inch LCD, Ethernet, Bluetooth V5.2, Wi-Fi 6 North America (NA) IEEE 802.11 a/b/g/n/ac/ax, Passive NFC tag for Tap and Pair, Latin Font, Real Time Clock (RTC), Direct Thermal (DT) 203 DPI, includes Power Supply, US Power Cord

**Included in the box:**

- PC45d
- PC45 Regulatory Sheet (PC45-ML-RS-01)
- Power Supply (203-186-200)
- USB Cable (321-576-004)



- US Power Cord

Note: Not all printer combinations are available in every region. Check your local Price Book to see which part numbers are available for sale.

**Honeywell Repair Services**

SVCPC45-SG3N

PC45, Edge Service, Gold Maintenance Contract, 3 Year, New Contract

**ADD** SVCPRINTHEAD-PRN3

AddOn, Edge Service, Printhead Refresh Service, 203 or 300 DPI, 3-Year Contract

**ADD** SVCACC-PRN3

AddOn, Edge Service, Accessory Service, Printer, 3 Year

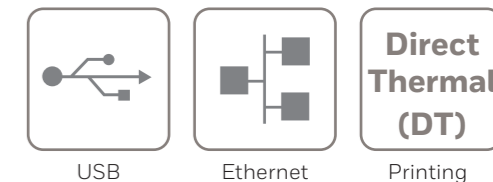

# PC45d HEALTHCARE FEATURE OVERVIEW

**Tear Off - Full Touch Display - Direct Thermal**



### PC45d Healthcare - Full Touch - Direct Thermal - 203 DPI

**PC45D10000200**

PC45d, 4-inch, Full Touch 3.5-inch LCD, Healthcare, Ethernet, Latin Font, Real Time Clock (RTC), Direct Thermal (DT) 203 DPI, includes Power Supply, No Power Cord

Included in the box:

- PC45d
- PC45 Regulatory Sheet (PC45-ML-RS-01)
- Power Supply (203-186-200)
- USB Cable (321-576-004)



- No Power Cord

### Honeywell Repair Services

SVCPC45-SG3N

PC45, Edge Service, Gold Maintenance Contract, 3 Year, New Contract

**ADD** SVCPRINTHEAD-PRN3

AddOn, Edge Service, Printhead Refresh Service, 203 or 300 DPI, 3-Year Contract

**ADD** SVCACC-PRN3

AddOn, Edge Service, Accessory Service, Printer, 3 Year

Note: Not all printer combinations are available in every region. Check your local Price Book to see which part numbers are available for sale.

# PC45d HEALTHCARE FEATURE OVERVIEW

**Tear Off - Full Touch Display - Direct Thermal -  
Wi-Fi/ Bluetooth (NA)**

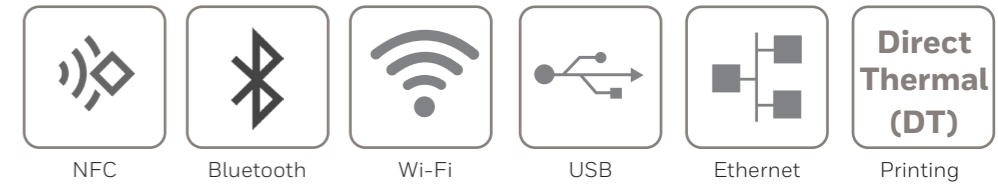

## PC45d Healthcare - Full Touch - Wi-Fi/ Bluetooth (NA) - Direct Thermal - 203 DPI

**PC45D110000201**

PC45d, 4-inch, Full Touch 3.5-inch LCD, Healthcare, Ethernet, Bluetooth V5.2, Wi-Fi 6 North America (NA) IEEE 802.11 a/b/g/n/ac/ax, Passive NFC tag for Tap and Pair, Latin Font, Real Time Clock (RTC), Direct Thermal (DT) 203 DPI, includes Power Supply, US Power Cord

### Included in the box:

- PC45d
- PC45 Regulatory Sheet (PC45-ML-RS-01)
- Power Supply (203-186-200)
- USB Cable (321-576-004)



- US Power Cord

Note: Not all printer combinations are available in every region. Check your local Price Book to see which part numbers are available for sale.

### Honeywell Repair Services

SVCPC45-SG3N

PC45, Edge Service, Gold Maintenance Contract, 3 Year, New Contract

**ADD** SVCPRINTHEAD-PRN3

AddOn, Edge Service, Printhead Refresh Service, 203 or 300 DPI, 3-Year Contract

**ADD** SVCACC-PRN3

AddOn, Edge Service, Accessory Service, Printer, 3 Year

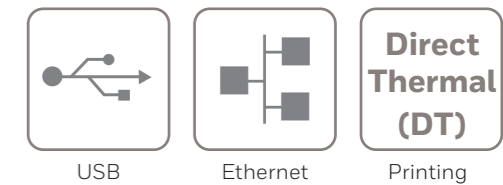

# PC45d LINERLESS FEATURE OVERVIEW

**Tear Off - Full Touch Display - Direct Thermal**



### PC45d - Full Touch - Linerless - Direct Thermal - 203 DPI

**PC45D200000200**

PC45d, 4-inch, Full Touch 3.5-inch LCD, Linerless, Ethernet, Latin Font, Real Time Clock (RTC), Direct Thermal (DT) 203 DPI, includes Power Supply, No Power Cord

Included in the box:

- PC45d
- PC45 Regulatory Sheet (PC45-ML-RS-01)
- Power Supply (203-186-200)
- USB Cable (321-576-004)



- No Power Cord

### Honeywell Repair Services

SVCPC45-SG3N

PC45, Edge Service, Gold Maintenance Contract, 3 Year, New Contract

**ADD** SVCPRINTHEAD-PRN3

AddOn, Edge Service, Printhead Refresh Service, 203 or 300 DPI, 3-Year Contract

**ADD** SVCACC-PRN3

AddOn, Edge Service, Accessory Service, Printer, 3 Year

Note: Not all printer combinations are available in every region. Check your local Price Book to see which part numbers are available for sale.

# PC45d LINERLESS FEATURE OVERVIEW

**Tear Off - Full Touch Display - Direct Thermal - RFID (NA) - Wi-Fi/ Bluetooth (NA)**



## PC45d - Full Touch - Linerless - Wi-Fi/ Bluetooth (NA) - UHF RFID - Direct Thermal - 300 DPI

**PC45D21NA01301**

PC45d, 4-inch, Full Touch 3.5-inch LCD, Linerless, Ethernet, Bluetooth V5.2, Wi-Fi 6 North America (NA) IEEE 802.11 a/b/g/n/ac/ax, Passive NFC tag for Tap and Pair, Latin Font, Real Time Clock (RTC), UHF RFID North America (NA), Media Low Sensor, Direct Thermal (DT) 300 DPI, includes Power Supply, US Power Cord

Included in the box:

- PC45d
- PC45 Regulatory Sheet (PC45-ML-RS-01)
- Power Supply (203-186-200)
- USB Cable (321-576-004)



- US Power Cord

Note: Not all printer combinations are available in every region. Check your local Price Book to see which part numbers are available for sale.

### Honeywell Repair Services

SVCPC45-SG3N

PC45, Edge Service, Gold Maintenance Contract, 3 Year, New Contract

**ADD** SVCPRINTHEAD-PRN3





AddOn, Edge Service, Printhead Refresh Service, 203 or 300 DPI, 3-Year Contract

**ADD** SVCACC-PRN3

AddOn, Edge Service, Accessory Service, Printer, 3 Year

# PC45d CONFIGURATION MAP

## Desktop Printer

VERSION	MODEL	CONNECTIVITY	I/O OPTION 1	MEDIA OPTION	PRINT OPTION	POWER CORD	DESCRIPTION	NOTES
<b>PC45</b>								
<b>D</b>							Direct Thermal (DT)	2 x USB A Port (USB 2.0 Host), 1 x USB B Port (USB 2.0 Device), Real Time Clock (RTC)
	<b>0</b>						Standard (Grey Color)	Includes Standard Platen Roller Part# 205-187-002 PC45d Standard Platen Roller
	<b>1</b>						Healthcare (Lyric White Color)	Disinfectant Ready Housing Includes Standard Platen Roller Part# 205-187-002 PC45d Standard Platen Roller
	<b>2</b>						Linerless (Grey Color)	Includes Linerless Platen Roller Part# 205-187-003 PC45d Linerless Platen Roller
	<b>0</b>						Ethernet	 Ethernet 10/100 Mbps
	<b>1</b>						Ethernet + WLAN North America (NA) + Bluetooth + Passive NFC Tag	Available as Kit - Part# 205-190-011 Wi-Fi 6 North America (NA) 802.11 a/b/g/n/ac/ax + V5.2 Bluetooth + Passive NFC Tag Kit
	<b>2</b>						Ethernet + WLAN Rest Of World (ROW) + Bluetooth + Passive NFC Tag	Available as Kit - Part# 205-190-012 Wi-Fi 6 Rest Of World (ROW) 802.11 a/b/g/n/ac/ax + V5.2 Bluetooth + Passive NFC Tag Kit
	<b>3</b>						Ethernet + Serial	 Ethernet 10/100 Mbps, RS232 Serial Port
	<b>4</b>						Ethernet + Serial + WLAN North America (NA) + Bluetooth + Passive NFC Tag	 Ethernet 10/100 Mbps, RS232 Serial Port, Wi-Fi 6 802.11 a/b/g/n/ac/ax North America (NA) V5.2 Bluetooth, Passive NFC Tag Kit
	<b>5</b>						Ethernet + Serial + WLAN Rest Of World (ROW) + Bluetooth + Passive NFC Tag	 Ethernet 10/100 Mbps, RS232 Serial Port, Wi-Fi 6 802.11 a/b/g/n/ac/ax Rest Of World (ROW) V5.2 Bluetooth, Passive NFC Tag Kit
	<b>00</b>						None	
	<b>EU</b>						UHF RFID Europe (EU) - 869MHz	IM21 RFID Module
	<b>NA</b>						UHF RFID North America (NA) - 915MHz	IM21 RFID Module
	<b>00</b>						None	
	<b>01</b>						Media Low Sensor	
	<b>20</b>						203 DPI	Available as Kit - Part# 225-783-001 PRINTHEAD ASSY 203 DPI,PC43D/PC43T/PD43/PC45D/PC45T
	<b>30</b>						300 DPI	Available as Kit - Part# 225-784-001 PRINTHEAD ASSY 300 DPI,PC43D/PC43T/PD43/PC45D/PC45T
	<b>0</b>						None	AC Power Cord C13 Type Connector
	<b>1</b>						US Power Cord	AC Power Cord C13 Type Connector
	<b>2</b>						EU Power Cord	AC Power Cord C13 Type Connector



# PC45t PRINTING OPTIONS



## Tear Off

Most commonly used, print any number of labels and simply tear the labels off from the printer at the end of the print job. This method of printing is available on any PC45t configuration.



## Cutter

A cutter can be added to any configuration of PC45t, simply cutting between labels, or at intervals on continuous media. This method of printing is available on any PC45t configuration.  
205-188-006      PC45t Cutter + LTS Kit



## Peel & Present (Self-Strip)

Self-Strip prints and presents only one label at a time already peeled from the backing strip/ liner, the next label will only be printed once the original label is removed from the media path.  
205-188-001      PC45t Self-Strip + LTS Kit



## External Media Holder

Provides support for media up to 21.27 cm (8.375 in) rolls of media for the PC45t.  
205-190-005      External Media Holder

ID = Inside Diameter  
OD = Outside Diameter

# PC45t MEDIA

## Specifications

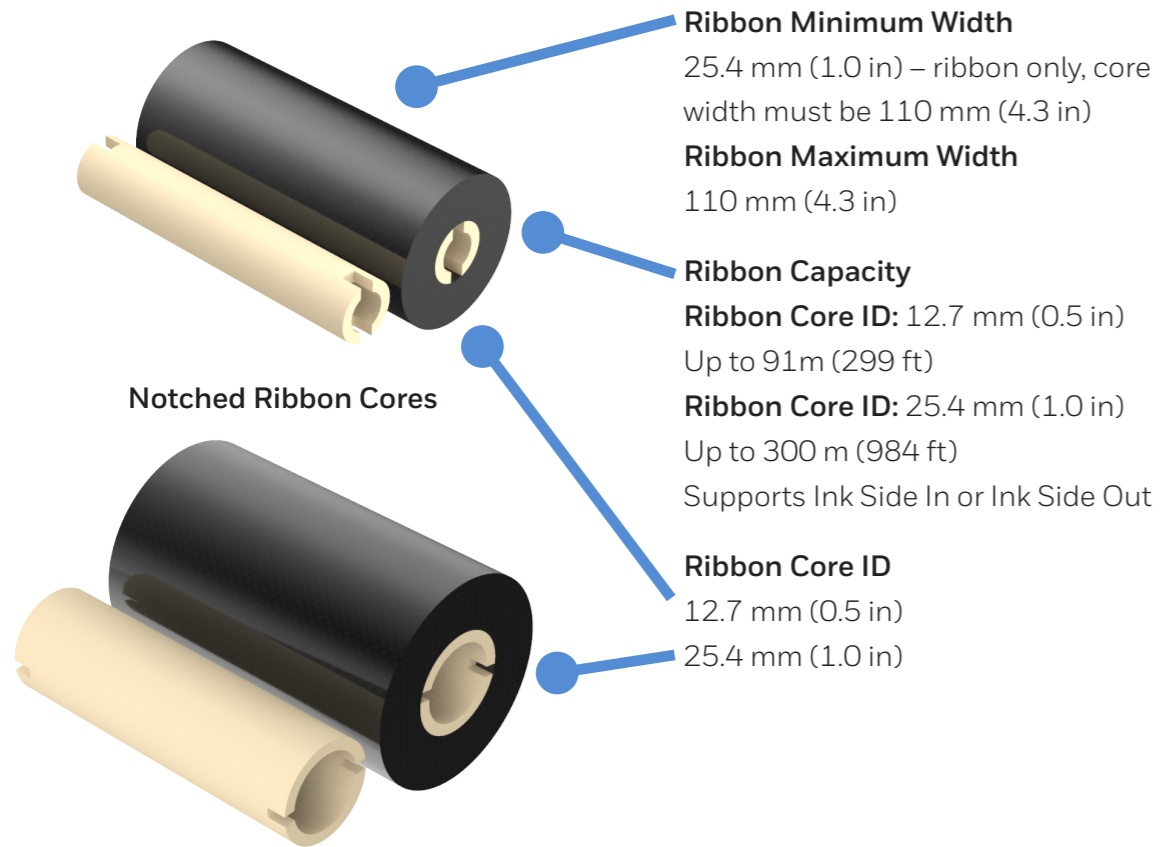

- Ribbon Minimum Width**  
25.4 mm (1.0 in) – ribbon only, core width must be 110 mm (4.3 in)
- Ribbon Maximum Width**  
110 mm (4.3 in)
- Ribbon Capacity**
- Ribbon Core ID: 12.7 mm (0.5 in)**  
Up to 91m (299 ft)
- Ribbon Core ID: 25.4 mm (1.0 in)**  
Up to 300 m (984 ft)  
Supports Ink Side In or Ink Side Out
- Ribbon Core ID**  
12.7 mm (0.5 in)
- 25.4 mm (1.0 in)

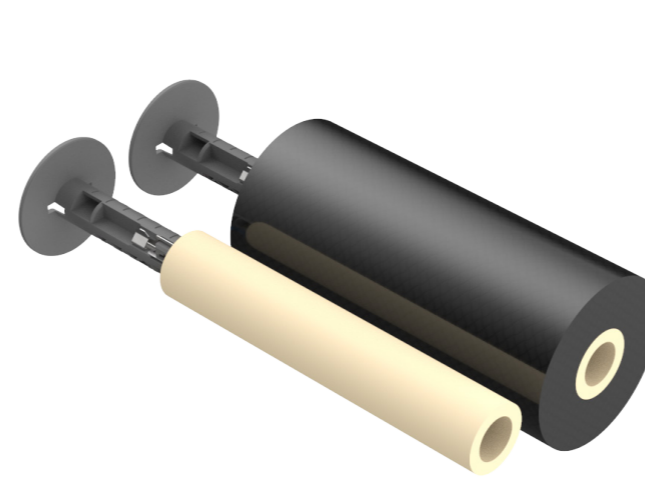

**Ribbon Adapter for Notchless Ribbon Cores**  
205-188-010 12.7 mm (0.5 in) Ribbon Core Adapters

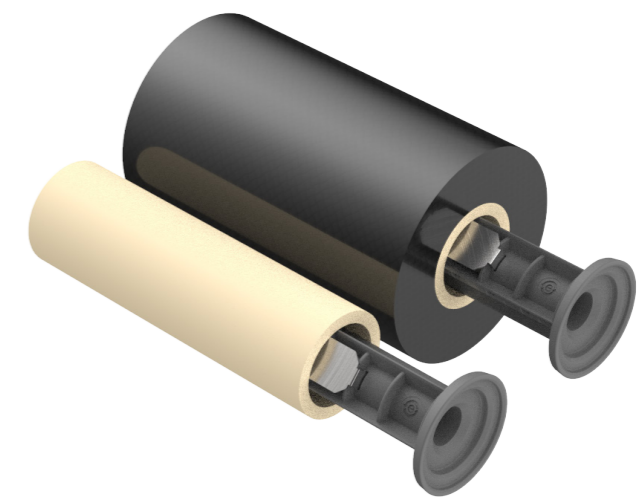

**Ribbon Adapter for Notchless Ribbon Cores**  
205-188-009 25.4 mm (1.0 in) Ribbon Core Adapters

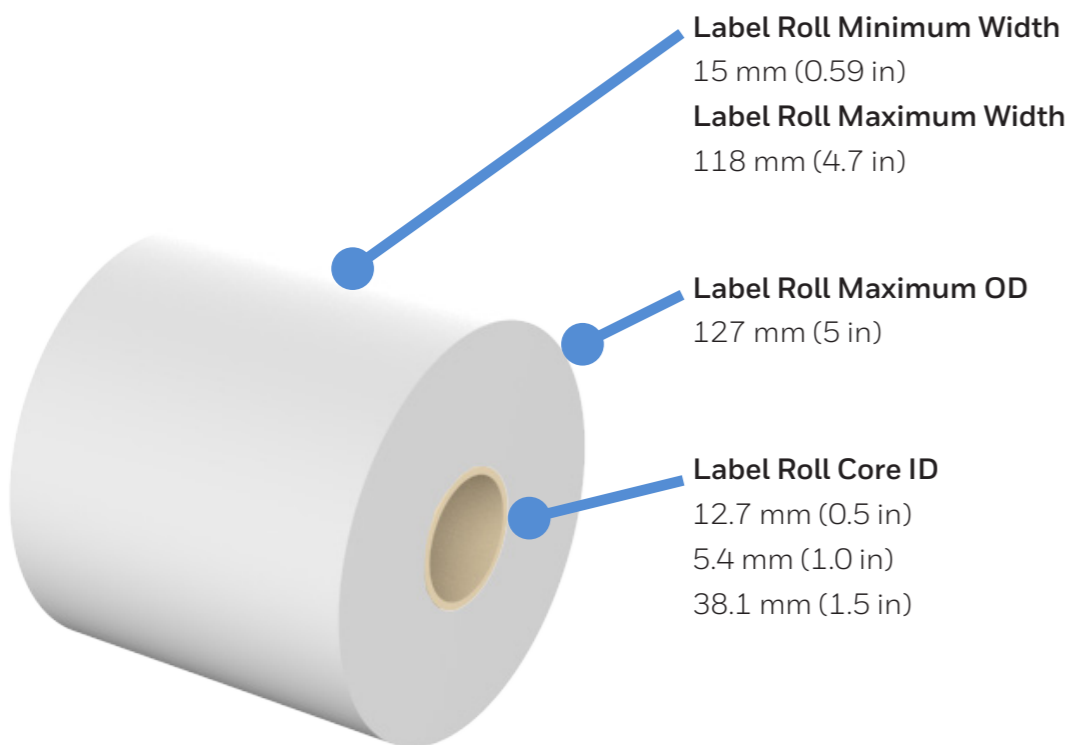

- Label Roll Minimum Width**  
15 mm (0.59 in)
- Label Roll Maximum Width**  
118 mm (4.7 in)
- Label Roll Maximum OD**  
127 mm (5 in)
- Label Roll Core ID**  
12.7 mm (0.5 in)  
5.4 mm (1.0 in)  
38.1 mm (1.5 in)



**Ink Side In/ Ink Side Out Ribbon Switch**

**Minimum Label Length**

Tear Off	6.35 mm (0.25 in)
Peel-Off Kit	12.5 mm (0.49 in)
Cutter (Full Cut)	12.5 mm (0.49 in)
Cutter (Partial Cut)	25 mm (1.0 in)
Cutter (Linerless)	25 mm (1.0 in)
RFID	15 mm (0.6 in)

**Maximum Print Width**

203 dpi	104 mm (4.1 in)
300 dpi	106 mm (4.2 in)



ID = Inside Diameter  
OD = Outside Diameter

# PC45t MEDIA

## Specifications



**Media Hanger + Label Roll Core 38 mm (1.5 in) ID**

Shown with Label Roll 127 mm (5 in) OD

Typical length of material with typical thickness of labels ~ 72 m

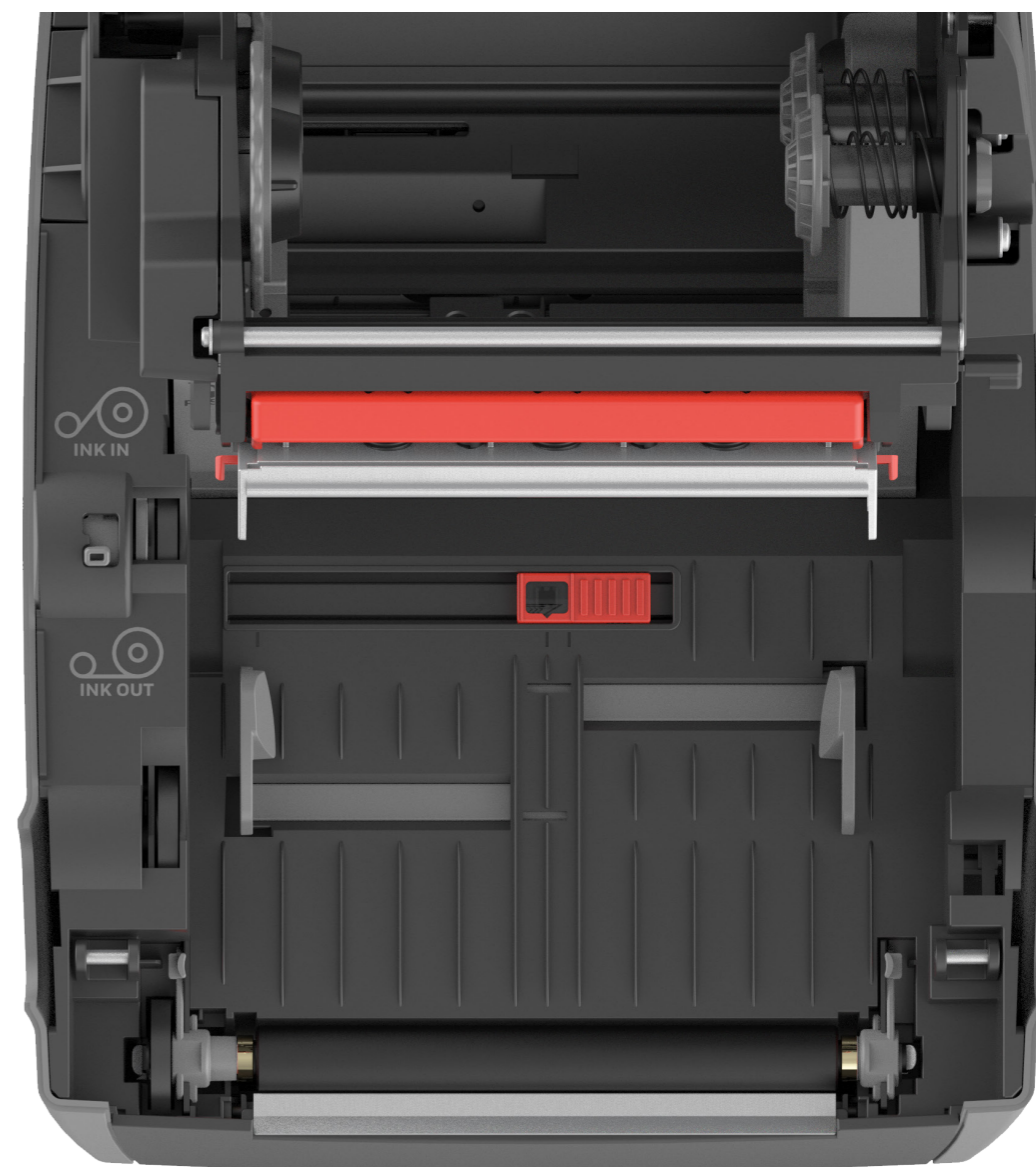

**Adjustable Media Sensor**

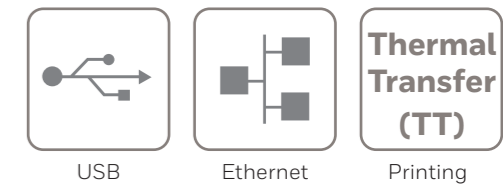

# PC45t FEATURE OVERVIEW

**Tear Off - Full Touch Display - Thermal Transfer**



### PC45t - Full Touch - Thermal Transfer - 203 DPI

**PC45T00000200**

PC45t, 4-inch, Full Touch 3.5-inch LCD, Ethernet, Latin Font, Real Time Clock (RTC), Thermal Transfer (TT) 203 DPI, includes Power Supply, No Power Cord

### PC45t - Full Touch - Thermal Transfer - 300 DPI

**PC45T00000300**

PC45t, 4-inch, Full Touch 3.5-inch LCD, Ethernet, Latin Font, Real Time Clock (RTC), Thermal Transfer (TT) 300 DPI, includes Power Supply, No Power Cord

#### Included in the box:

- PC45t
- PC45 Regulatory Sheet (PC45-ML-RS-01)
- Power Supply (203-186-200)



- No Power Cord

- 0.5 in Ribbon Take Up Core (180000565390)



- USB Cable (321-576-004)



#### Honeywell Repair Services

SVCPC45-SG3N

PC45, Edge Service, Gold Maintenance Contract, 3 Year, New Contract

**ADD** SVCPRINTHEAD-PRN3

AddOn, Edge Service, Printhead Refresh Service, 203 or 300 DPI, 3-Year Contract

**ADD** SVCACC-PRN3

AddOn, Edge Service, Accessory Service, Printer, 3 Year

Note: Not all printer combinations are available in every region. Check your local Price Book to see which part numbers are available for sale.

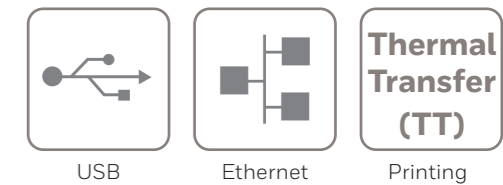

# PC45t FEATURE OVERVIEW

**Tear Off - Full Touch Display - Thermal Transfer**



### PC45t - Full Touch - Thermal Transfer - 203 DPI

**PC45T000003200**

PC45t, 4-inch, Full Touch 3.5-inch LCD, Ethernet, Latin Font, Real Time Clock (RTC), 1.0 inch Notchless Ribbon Adapters, Thermal Transfer (TT) 203 DPI, includes Power Supply, No Power Cord

### PC45t - Full Touch - Thermal Transfer - 300 DPI

**PC45T000003300**

PC45t, 4-inch, Full Touch 3.5-inch LCD, Ethernet, Latin Font, Real Time Clock (RTC), 1.0 inch Notchless Ribbon Adapters, Thermal Transfer (TT) 300 DPI, includes Power Supply, No Power Cord

Included in the box:

- PC45t
- PC45 Regulatory Sheet (PC45-ML-RS-01)
- Power Supply (203-186-200)



- No Power Cord

- 0.5 in Ribbon Take Up Core (180000565390)



- 1.0 in Ribbon Take Up Core (180000565400)

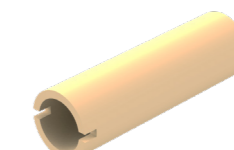

- USB Cable (321-576-004)



- 1.0 in Ribbon Adapters (205-188-009)



### Honeywell Repair Services

SVCPC45-SG3N

PC45, Edge Service, Gold Maintenance Contract, 3 Year, New Contract

**ADD** SVCPRINTHEAD-PRN3

AddOn, Edge Service, Printhead Refresh Service, 203 or 300 DPI, 3-Year Contract

**ADD** SVCACC-PRN3

AddOn, Edge Service, Accessory Service, Printer, 3 Year

Note: Not all printer combinations are available in every region. Check your local Price Book to see which part numbers are available for sale.

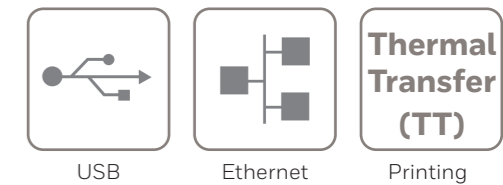

# PC45t FEATURE OVERVIEW

**Tear Off - Full Touch Display - Thermal Transfer**



### PC45t - Full Touch - Thermal Transfer - 203 DPI

**PC45T00000201**

PC45t, 4-inch, Full Touch 3.5-inch LCD, Ethernet, Latin Font, Real Time Clock (RTC), Thermal Transfer (TT) 203 DPI, includes Power Supply, US Power Cord

### PC45t - Full Touch - Thermal Transfer - 300 DPI

**PC45T00000301**

PC45t, 4-inch, Full Touch 3.5-inch LCD, Ethernet, Latin Font, Real Time Clock (RTC), Thermal Transfer (TT) 300 DPI, includes Power Supply, US Power Cord

#### Included in the box:

- PC45t
- PC45 Regulatory Sheet (PC45-ML-RS-01)
- Power Supply (203-186-200)



- US Power Cord

- 0.5 in Ribbon Take Up Core (180000565390)



- USB Cable (321-576-004)



#### Honeywell Repair Services

SVCPC45-SG3N

PC45, Edge Service, Gold Maintenance Contract, 3 Year, New Contract

**ADD** SVCPRINTHEAD-PRN3

AddOn, Edge Service, Printhead Refresh Service, 203 or 300 DPI, 3-Year Contract

**ADD** SVCACC-PRN3

AddOn, Edge Service, Accessory Service, Printer, 3 Year

Note: Not all printer combinations are available in every region. Check your local Price Book to see which part numbers are available for sale.

# PC45t FEATURE OVERVIEW

**Tear Off - Full Touch Display - Thermal Transfer - RFID (EU)**

**Wi-Fi/ Bluetooth (ROW)**



## PC45t - Full Touch - Wi-Fi/ Bluetooth (ROW) - UHF RFID - Thermal Transfer - 300 DPI

**PC45T02EU01300**

PC45t, 4-inch, Full Touch 3.5-inch LCD, Ethernet, Bluetooth V5.2, Wi-Fi 6 Rest of World (ROW) IEEE 802.11 a/b/g/n/ac/ax, Passive NFC tag for Tap and Pair, Latin Font, Real Time Clock (RTC), UHF RFID Europe/ ROW (EU), Media Low Sensor, Thermal Transfer (TT) 300 DPI, includes Power Supply, No Power Cord

Included in the box:

- PC45t
- PC45 Regulatory Sheet (PC45-ML-RS-01)
- Power Supply (203-186-200)
- 0.5 in Ribbon Take Up Core (180000565390)
- USB Cable (321-576-004)
- No Power Cord



Note: Not all printer combinations are available in every region. Check your local Price Book to see which part numbers are available for sale.

### Honeywell Repair Services

SVCPC45-SG3N

PC45, Edge Service, Gold Maintenance Contract, 3 Year, New Contract

**ADD** SVCPRINTHEAD-PRN3

AddOn, Edge Service, Printhead Refresh Service, 203 or 300 DPI, 3-Year Contract

**ADD** SVCACC-PRN3

AddOn, Edge Service, Accessory Service, Printer, 3 Year

# PC45t FEATURE OVERVIEW

**Tear Off - Full Touch Display - Thermal Transfer - RFID (NA)**

**Wi-Fi/ Bluetooth (NA)**



## PC45t - Full Touch - Wi-Fi/ Bluetooth (NA) - UHF RFID - Thermal Transfer - 203 DPI

**PC45T01NA01201**

PC45t, 4-inch, Full Touch 3.5-inch LCD, Ethernet, Bluetooth V5.2, Wi-Fi 6 North America (NA) IEEE 802.11 a/b/g/n/ac/ax, Passive NFC tag for Tap and Pair, Latin Font, Real Time Clock (RTC), UHF RFID North America (NA), Media Low Sensor, Thermal Transfer (TT) 203 DPI, includes Power Supply, US Power Cord

Included in the box:

- PC45t
- PC45 Regulatory Sheet (PC45-ML-RS-01)
- Power Supply (203-186-200)
- 0.5 in Ribbon Take Up Core (180000565390)



- US Power Cord



- USB Cable (321-576-004)



Note: Not all printer combinations are available in every region. Check your local Price Book to see which part numbers are available for sale.

### Honeywell Repair Services

SVCPC45-SG3N

PC45, Edge Service, Gold Maintenance Contract, 3 Year, New Contract

**ADD** SVCPRINTHEAD-PRN3

AddOn, Edge Service, Printhead Refresh Service, 203 or 300 DPI, 3-Year Contract

**ADD** SVCACC-PRN3

AddOn, Edge Service, Accessory Service, Printer, 3 Year

# PC45t FEATURE OVERVIEW

**Tear Off - Full Touch Display - Thermal Transfer -  
Wi-Fi/ Bluetooth (ROW)**

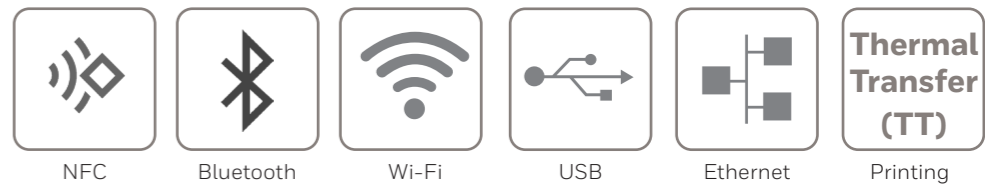

**PC45t - Full Touch - Wi-Fi/ Bluetooth (ROW) - Thermal Transfer - 203 DPI**

**PC45T020000200**

PC45t, 4-inch, Full Touch 3.5-inch LCD, Ethernet, Bluetooth V5.2, Wi-Fi 6 Rest of World (ROW) IEEE 802.11 a/b/g/n/ac/ax, Passive NFC tag for Tap and Pair, Latin Font, Real Time Clock (RTC), Thermal Transfer (TT) 203 DPI, includes Power Supply, No Power Cord

**Included in the box:**

- PC45t
- PC45 Regulatory Sheet (PC45-ML-RS-01)
- Power Supply (203-186-200)



- No Power Cord

- 0.5 in Ribbon Take Up Core (180000565390)



- USB Cable (321-576-004)



Note: Not all printer combinations are available in every region. Check your local Price Book to see which part numbers are available for sale.

**Honeywell Repair Services**

SVCPC45-SG3N

PC45, Edge Service, Gold Maintenance Contract, 3 Year, New Contract

**ADD** SVCPRINTHEAD-PRN3

AddOn, Edge Service, Printhead Refresh Service, 203 or 300 DPI, 3-Year Contract

**ADD** SVCACC-PRN3

AddOn, Edge Service, Accessory Service, Printer, 3 Year

# PC45t FEATURE OVERVIEW

**Tear Off - Full Touch Display - Thermal Transfer -  
Wi-Fi/ Bluetooth (NA)**

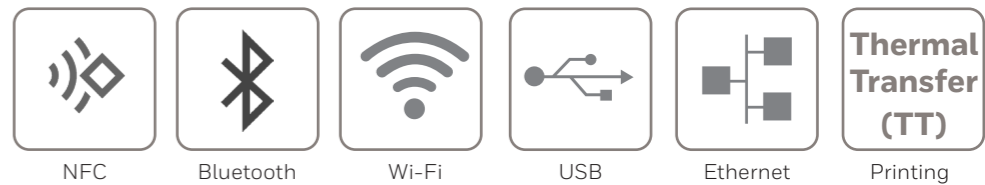

### PC45t - Full Touch - Wi-Fi/ Bluetooth (NA) - Thermal Transfer - 203 DPI

**PC45T01NA01201**

PC45t, 4-inch, Full Touch 3.5-inch LCD, Ethernet, Bluetooth V5.2, Wi-Fi 6 North America (NA) IEEE 802.11 a/b/g/n/ac/ax, Passive NFC tag for Tap and Pair, Latin Font, Real Time Clock (RTC), UHF RFID North America (NA), Media Low Sensor, Thermal Transfer (TT) 203 DPI, includes Power Supply, US Power Cord

Included in the box:

- PC45t
- PC45 Regulatory Sheet (PC45-ML-RS-01)
- Power Supply (203-186-200)
- 0.5 in Ribbon Take Up Core (180000565390)



- US Power Cord



- USB Cable (321-576-004)



Note: Not all printer combinations are available in every region. Check your local Price Book to see which part numbers are available for sale.

### Honeywell Repair Services

SVCPC45-SG3N

PC45, Edge Service, Gold Maintenance Contract, 3 Year, New Contract

**ADD** SVCPRINTHEAD-PRN3





AddOn, Edge Service, Printhead Refresh Service, 203 or 300 DPI, 3-Year Contract

**ADD** SVCACC-PRN3

AddOn, Edge Service, Accessory Service, Printer, 3 Year

# PC45t CONFIGURATION MAP

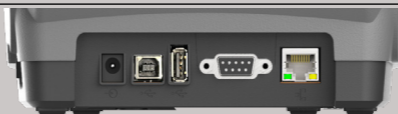
## Desktop Printer

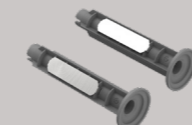
VERSION	MODEL	CONNECTIVITY	I/O OPTION 1	MEDIA OPTION	PRINT OPTION	POWER CORD	DESCRIPTION	NOTES
<b>PC45</b>								
T	0						Thermal Transfer (TT) Standard (Grey Color)	2 x USB A Port (USB 2.0 Host), 1 x USB B Port (USB 2.0 Device), Real Time Clock (RTC) Includes Standard Platen Roller Part# 205-188-002 PC45t Standard Platen Roller
	0						Ethernet	 Ethernet 10/100 Mbps
	1						Ethernet + WLAN North America (NA) + Bluetooth + Passive NFC Tag	Available as Kit - Part# 205-190-011 Wi-Fi 6 North America (NA) 802.11 a/b/g/n/ac/ax + V5.2 Bluetooth + Passive NFC Tag Kit
	2						Ethernet + WLAN Rest Of World (ROW) + Bluetooth + Passive NFC Tag	Available as Kit - Part# 205-190-012 Wi-Fi 6 Rest Of World (ROW) 802.11 a/b/g/n/ac/ax + V5.2 Bluetooth + Passive NFC Tag Kit
	3						Ethernet + Serial	 Ethernet 10/100 Mbps, RS232 Serial Port
	4						Ethernet + Serial + WLAN North America (NA) + Bluetooth + Passive NFC Tag	 Ethernet 10/100 Mbps, RS232 Serial Port, Wi-Fi 6 802.11 a/b/g/n/ac/ax North America (NA) V5.2 Bluetooth, Passive NFC Tag Kit
	5						Ethernet + Serial + WLAN Rest Of World (ROW) + Bluetooth + Passive NFC Tag	 Ethernet 10/100 Mbps, RS232 Serial Port, Wi-Fi 6 802.11 a/b/g/n/ac/ax Rest Of World (ROW) V5.2 Bluetooth, Passive NFC Tag Kit
	00						None	
	EU						UHF RFID Europe (EU) - 869MHz	IM21 RFID Module
	NA						UHF RFID North America (NA) - 915MHz	IM21 RFID Module
	00						None	
	01						Media Low Sensor	
	02						0.5 in Ribbon Adapters	 Available as Kit - Part# 205-188-010 0.5 in Ribbon Core Adapters
	03						1.0 in Ribbon Adapters	 Available as Kit - Part# 205-188-009 1.0 in Ribbon Core Adapters
	20						203 DPI	Available as Kit - Part# 225-783-001 PRINTHEAD ASSY 203 DPI,PC43D/PC43T/PD43/PC45D/PC45T
	30						300 DPI	Available as Kit - Part# 225-784-001 PRINTHEAD ASSY 300 DPI,PC43D/PC43T/PD43/PC45D/PC45T
	0						None	AC Power Cord C13 Type Connector
	1						US Power Cord	AC Power Cord C13 Type Connector
	2						EU Power Cord	AC Power Cord C13 Type Connector



# HONEYWELL EDGE SERVICES

## PC45d / PC45t – Repair Services

Honeywell Edge Services give you the confidence of having leading-class technologies combined with service and support plans that are designed to keep you operational for longer.

For a full description of maintenance services, including terms and conditions, please see <https://sps.honeywell.com/us/en/services/productivity/support-services/maintenance-services>

### Gold Repair Services – 3 Year

The Edge Services Gold Support contract allows flexibility for you to select the right coverage for your organization, including 5-Day Depot Repairs and:

#### Service Overview

- Repair or replacement (at Honeywell discretion) for damaged components, wear and tear, accidental damage
- Flexibility to add any Add-On Service

PART NUMBER	DESCRIPTION
SVCPC45-SG3N	PC45d/ PC45t, Edge Service, GOLD Maintenance Contract, 5 Day Turnaround, <b>3 Year</b> , New Contract

#### Add-On Accessory Replacement Service

Provides replacement cables, interface cards or platen rollers should they be damaged or stop working.

<b>ADD</b> SVCACC-PRN3	AddOn, Edge Service, Accessory Service , Printer, <b>3 Year</b>
------------------------	---

#### Add-On Printhead Refresh Service

Provides replacement 203 or 300 DPI printhead at 18 months post purchase.

<b>ADD</b> SVCPRINHEAD-PRN3	AddOn, Edge Service, Printhead Refresh Service, 200 or 300 dpi, <b>3 Year</b> , 1 replacement printhead
-----------------------------	---

#### Add-On Device Replacement Service

Replacement devices should a device be damaged beyond repair.

<b>ADD</b> SVCREPLACE-PRN3	AddOn, Edge Service, Device Replacement, Printer, <b>3 Year</b>
----------------------------	---

#### Add-On Cutter Replacement Service

Provides replacement cutters should they be damaged or stop working.

<b>ADD</b> SVCCUTTER1-PRN3	AddOn, Edge Service, Cutter Service for Printers, <b>3 Year</b>
----------------------------	---

#### Add-On Spare Management Service

Manages your spare pool.

<b>ADD</b> SVCSPAREMGMT-PRN3	AddOn, Edge Service, Advanced Exchange, Printer, <b>3 Year</b> . Customer owned spare pool, Minimum Purchase required, contact your local Honeywell Service Representative for more information.
------------------------------	--

#### Add-On 2-Day Turnaround Depot Upgrade

Upgrade your Gold Maintenance Contract from 5-Day to 2-Day turnaround at the repair depot.

<b>ADD</b> SVC2DAYDEPOT-PRN3	AddOn, Edge Service, 2-Day Depot Upgrade, 3-Year Agreement, Requires purchase of a <b>3 Year</b> Gold Maintenance Contract.
------------------------------	---

### Platinum Repair Services – 3 Year

The Edge Services Platinum Support contract offers 2-Day Depot Repairs or Spare Pool Management with 3 year contract that includes:

#### Service Overview

- Repair or replacement (at Honeywell discretion) for damaged components, wear and tear, accidental damage
- SVCREPLACE-PRN3 - Replacement devices should a device be damaged beyond repair
- SVCACC-PRN3 - Accessory replacement service
- SVCPRINHEAD-PRN3 - Provides replacement 203 or 300 DPI printhead at 18 months post purchase.
- SVCSPAREMGMT-PRN3 - Spare pool management (optional, minimum quantity required)
- SVCCUTTER1-PRN3 - Provides replacement cutters should they be damaged or stop working.
- Telephone-based technical support

PART NUMBER	DESCRIPTION
SVCPC45-SP3N	PC45d/ PC45t, Edge Service, PLATINUM, 2 Day Turnaround, 3 Year, New Contract



# HONEYWELL EDGE SERVICES

## PC45d / PC45t – Repair Services

Honeywell Edge Services give you the confidence of having leading-class technologies combined with service and support plans that are designed to keep you operational for longer.

For a full description of maintenance services, including terms and conditions, please see <https://sps.honeywell.com/us/en/services/productivity/support-services/maintenance-services>

### Gold Repair Services – 5 Year

The Edge Services Gold Support contract allows flexibility for you to select the right coverage for your organization, including 5-Day Depot Repairs and:

#### Service Overview

- Repair or replacement (at Honeywell discretion) for damaged components, wear and tear, accidental damage
- Flexibility to add any Add-On Service

PART NUMBER	DESCRIPTION
SVCPC45-SG5N	PC45d/ PC45t, Edge Service, GOLD Maintenance Contract, 5 Day Turnaround, <b>5 Year</b> , New Contract

#### Add-On Accessory Replacement Service

Provides replacement cables, interface cards or platen rollers should they be damaged or stop working.

<b>ADD</b> SVCACC-PRN5	AddOn, Edge Service, Accessory Service , Printer, <b>5 Year</b>
------------------------	---

#### Add-On Printhead Refresh Service

Provides replacement 203 or 300 DPI printhead at 18 and 36 months post purchase.

<b>ADD</b> SVCPRINHEAD-PRN5	AddOn, Edge Service, Printhead Refresh Service, 200 or 300 dpi, <b>5 Year</b> , 2 replacement printheads
-----------------------------	--

#### Add-On Device Replacement Service

Replacement devices should a device be damaged beyond repair.

<b>ADD</b> SVCREPLACE-PRN5	AddOn, Edge Service, Device Replacement, Printer, <b>5 Year</b>
----------------------------	---

#### Add-On Cutter Replacement Service

Provides replacement cutters should they be damaged or stop working.

<b>ADD</b> SVCCUTTER1-PRN5	AddOn, Edge Service, Cutter Service for Printers, <b>5 Year</b>
----------------------------	---

#### Add-On Spare Management Service

Manages your spare pool.

<b>ADD</b> SVCSPAREMGMT-PRN5	AddOn, Edge Service, Advanced Exchange, Printer, <b>5 Year</b> . Customer owned spare pool, Minimum Purchase required, contact your local Honeywell Service Representative for more information.
------------------------------	--

#### Add-On 2-Day Turnaround Depot Upgrade

Upgrade your Gold Maintenance Contract from 5-Day to 2-Day turnaround at the repair depot.

<b>ADD</b> SVC2DAYDEPOT-PRN5	AddOn, Edge Service, 2-Day Depot Upgrade, 5-Year Agreement, Requires purchase of a <b>5 Year</b> Gold Maintenance Contract.
------------------------------	---

### Platinum Repair Services – 5 Year

The Edge Services Platinum Support contract offers 2-Day Depot Repairs or Spare Pool Management with 5 year contract that includes:

#### Service Overview

- Repair or replacement (at Honeywell discretion) for damaged components, wear and tear, accidental damage
- SVCREPLACE-PRN5 - Replacement devices should a device be damaged beyond repair
- SVCACC-PRN5 - Accessory replacement service
- SVCPRINHEAD-PRN5 - Provides replacement 203 or 300 DPI printhead at 18 and 36 months post purchase
- SVCSPAREMGMT-PRN5 - Spare pool management (optional, minimum quantity required)
- SVCCUTTER1-PRN5 - Provides replacement cutters should they be damaged or stop working.
- Telephone-based technical support

PART NUMBER	DESCRIPTION
SVCPC45-SP5N	PC45d/ PC45t, Edge Service, PLATINUM, 2 Day Turnaround, 5 Year, New Contract



# HONEYWELL REPAIR SERVICES

## PC45d / PC45t - Repair Services Coverage

Service options tailored to customer requirements



PC45d



PC45t

Warranty Cover Against Product Defect

**BASIC Service**

**Gold Coverage:**

- Accidental Damage
- Wear & Tear

Includes Replacement of:

- Platen Roller



**Flexible GOLD Add-Ons ordered separately**

- SVCACC-PRN3 Accessories
- SVCPRINTHEAD-PRN3 Printhead Replacement
- SVCREPLACE-PRN3 Device Replacement
- SVCCUTTER1-PRN3 Cutter Replacement
- SVCSPAREMGMT-PRN3 Advanced Exchange



**GOLD Service**

**Platinum Coverage**

- Printhead Replacement
- Coverage for Cables and Interface Cards
- Cutter Replacement
- Accidental Damage
- Device Replacement
- Wear & Tear



Printhead  
(3 Year – 1 replacement printhead)  
(5 Year – 2 replacement printheads)

Cutter

Power Supply

**PLATINUM Service**

COVERAGE	PART NUMBER	DESCRIPTION
<b>BASIC</b>	SVCPC45-EXW3	PC45d/PC45t, BASIC, 10-15 Day Turnaround, 3 Years (1 Year Factory Warranty + 2 Year Extended)
<b>GOLD</b>	SVCPC45-SG3N	PC45d/PC45t, Edge Service, GOLD Maintenance Contract, 5 Day Turnaround, 3 Year, New Contract
<b>ADD</b>	SVCACC-PRN3	AddOn, Edge Service, Accessory Service, Printer, 3 Year.
<b>ADD</b>	SVCPRINTHEAD-PRN3	AddOn, Edge Service, 203 or 300 DPI Printhead Refresh Service, 3-Year Contract, 1 replacement printhead
<b>ADD</b>	SVCREPLACE-PRN3	AddOn, Edge Service, Device Replacement, Printer, 3 Year
<b>ADD</b>	SVCCUTTER1-PRN3	AddOn, Edge Service, Cutter Service for Printer, 3-Year
<b>ADD</b>	SVCSPAREMGMT-PRN3	AddOn, Edge Service, Advanced Exchange, Printer, 3 Year. Customer owned spare pool, Minimum Purchase required.
<b>PLATINUM</b>	SVCPC45-SP3N	PC45d/PC45t, Edge Service, PLATINUM, 2 Day Turnaround, 3 Year, New Contract

# ACCESSORIES

## PC45d / PC45t - Wi-Fi and Bluetooth Card

The Wi-Fi and Bluetooth card can be easily added to any PC45d or PC45t printer.



PC45 Top View



PART NUMBER	DESCRIPTION
205-190-011	Wi-Fi 6 North America (NA) 802.11 a/b/g/n/ac/ax + V5.2 Bluetooth + Passive NFC Tag Kit
205-190-012	Wi-Fi 6 Rest Of World (ROW) 802.11 a/b/g/n/ac/ax + V5.2 Bluetooth + Passive NFC Tag Kit

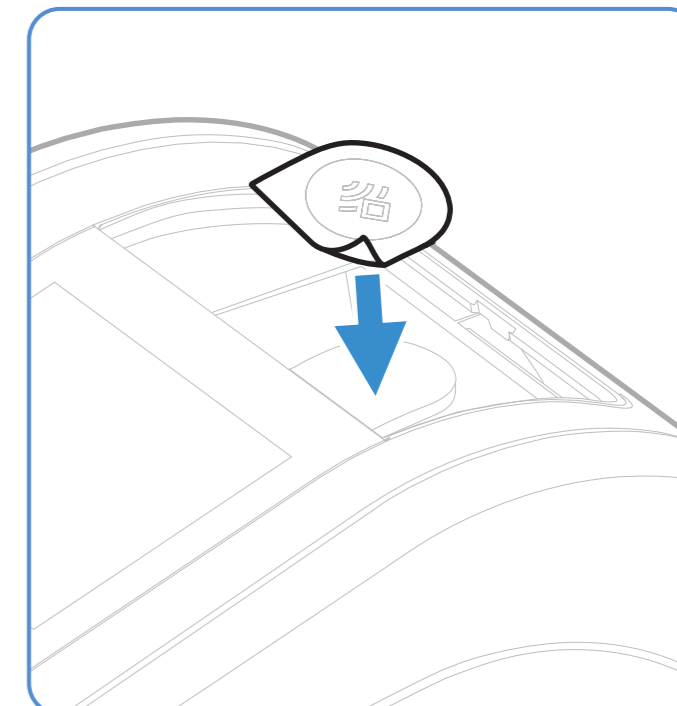

Insert NFC Tag Kit

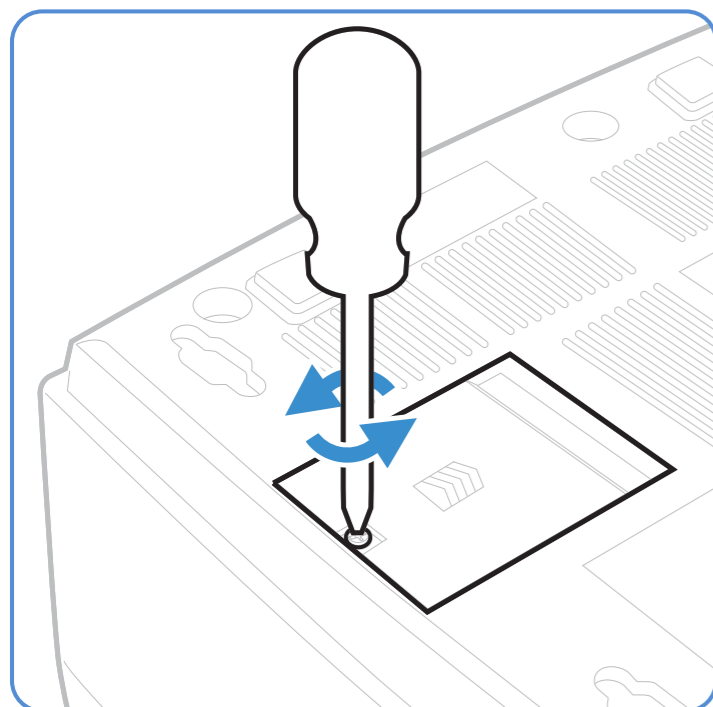

Loosen screw and open door

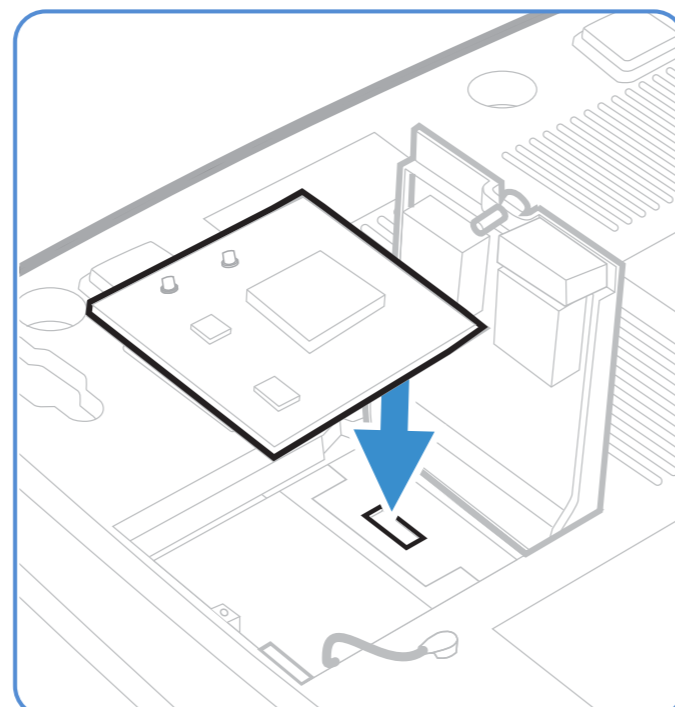

Insert Wi-Fi/ Bluetooth board

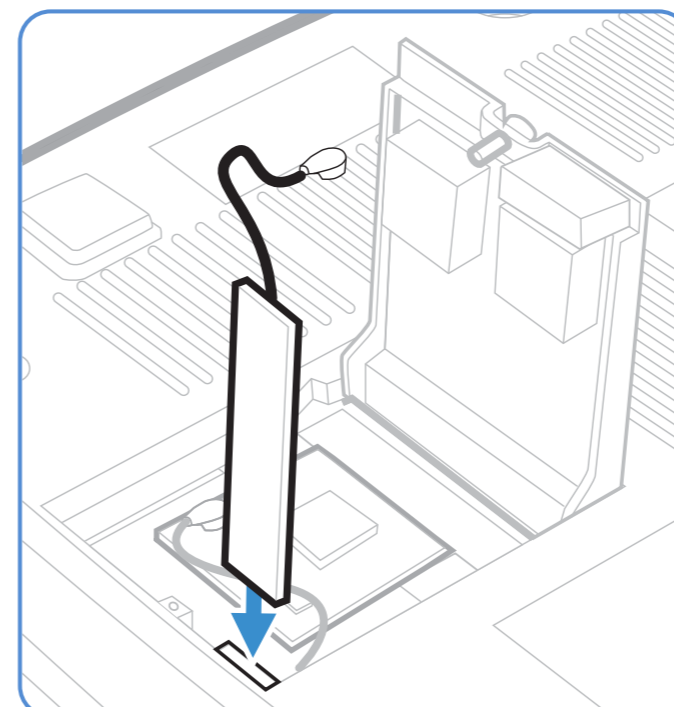

Connect the two antennas  
(2nd antenna is already included inside the PC45 printer)

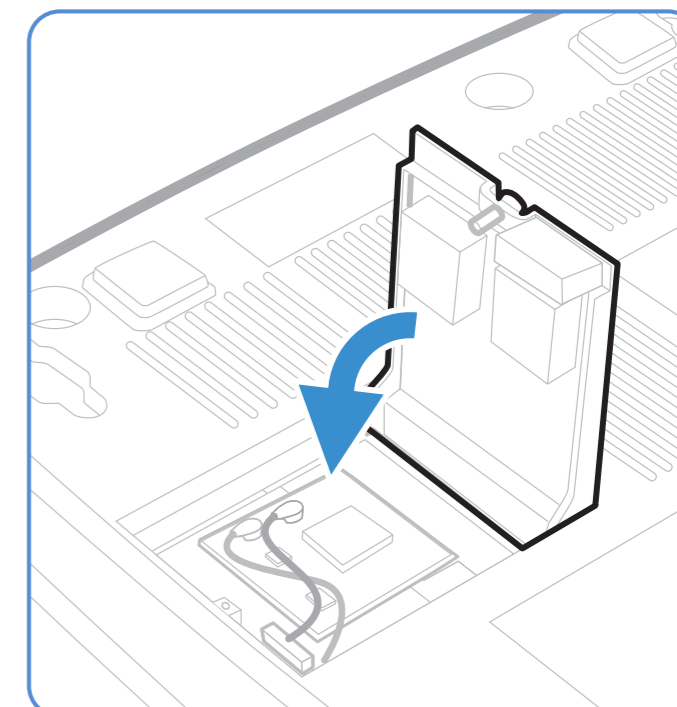

Close door

# ACCESSORIES

## PC45d / PC45d – WWAN 4G LTE – Cellular Modem

Expand your I/O with additional interface cards.

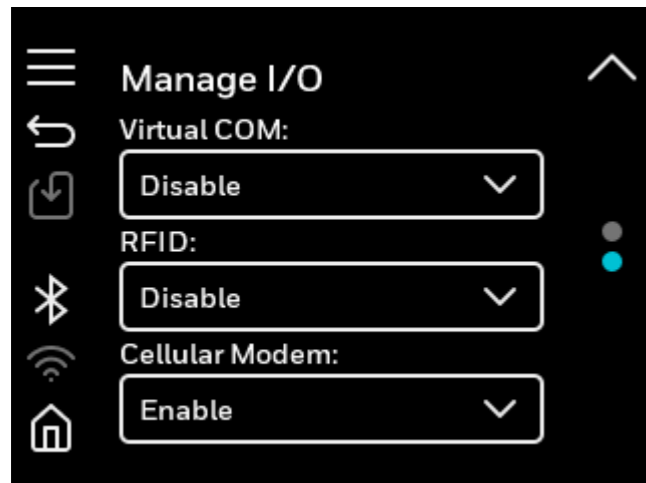

PART NUMBER	DESCRIPTION
205-190-008	Cellular Modem,Assy,PC45 (includes antenna)



PC45d WWAN Rear I/O View

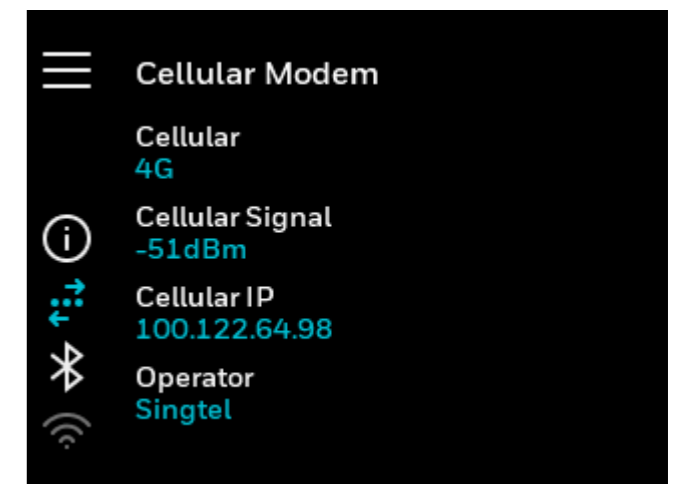
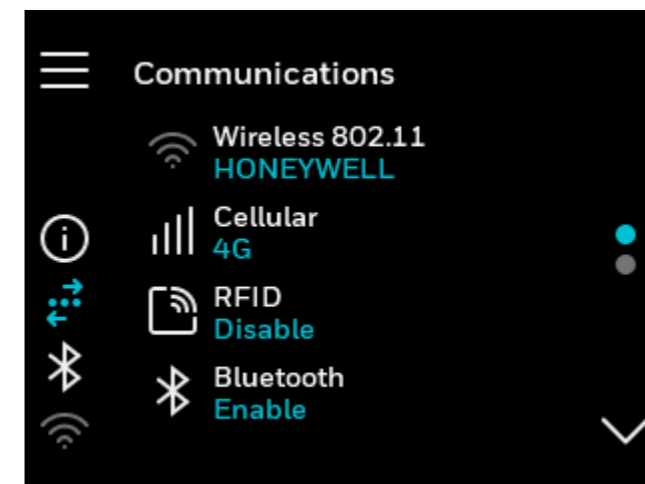
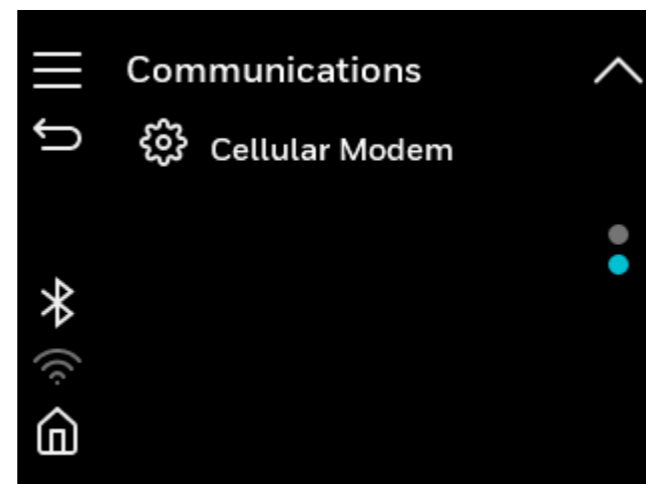

# ACCESSORIES

## PC45d Cutters

In cut-off printing, each label is automatically cut from the media roll immediately after the label is printed. You can print on non-adhesive, continuous label stock, and also self-adhesive labels with a liner. PC45d also supports linerless printing which has an option for a linerless cutter.



Standard Cutter



Linerless Cutter

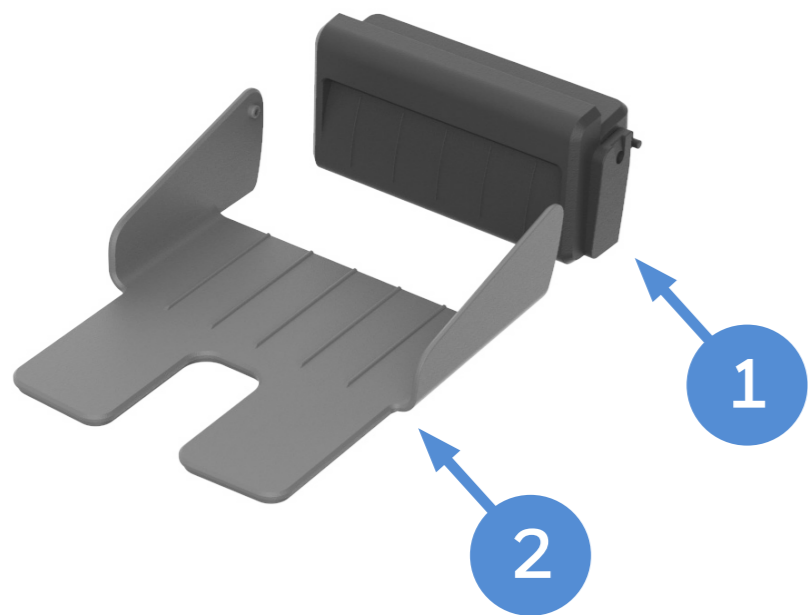

PART NUMBER	MEDIA	DESCRIPTION
1	RECEIPT & LABELS	Cutter Kit for PC45d (order Cutter Tray separately)
2		PC45d/ PC45t Cutter Tray
3	LINERLESS	Linerless Cutter Kit for PC45d

## PC45t Cutter

In cut-off printing, each label is automatically cut from the media roll immediately after the label is printed. You can print on non-adhesive, continuous label stock, and also self-adhesive labels with a liner.



Standard Cutter

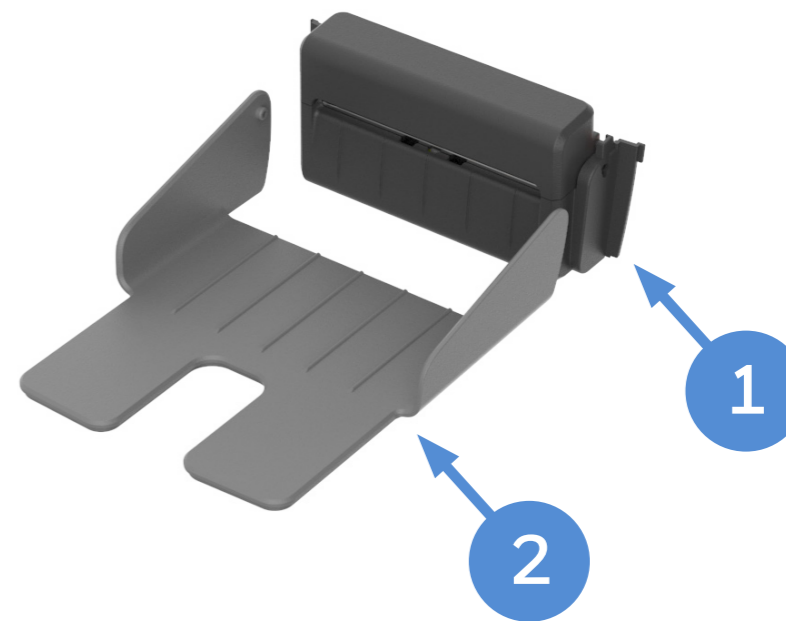

PART NUMBER	MEDIA	DESCRIPTION
1	RECEIPT & LABELS	Cutter Kit for PC45t (order Cutter Tray separately)
2		PC45d/ PC45t Cutter Tray

# ACCESSORIES

## PC45d Self Strip

To use the self strip accessory for printing, you print labels on self-adhesive label stock with a liner. As each label is printed, the label is automatically peeled from the liner and is presented at the front of the printer for manual removal.



Standard Self Strip



Healthcare Self Strip

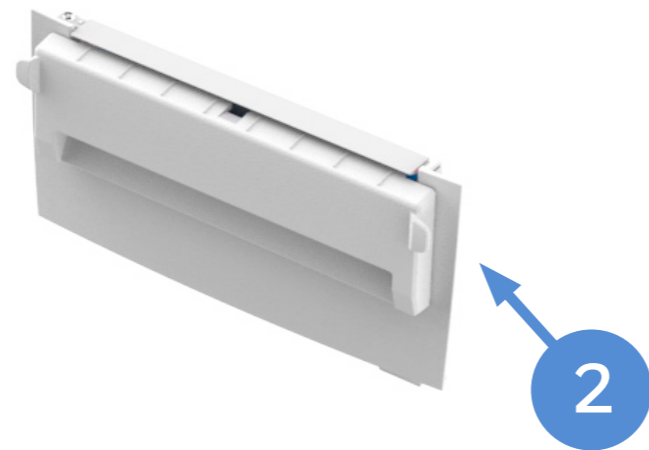
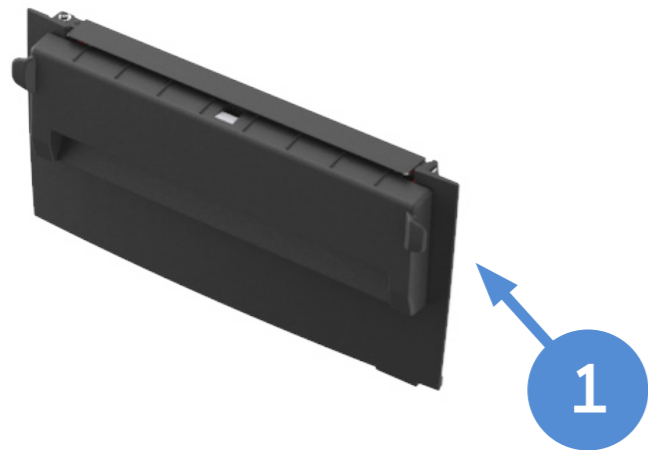

	PART NUMBER	MEDIA	DESCRIPTION
1	205-187-001	LABELS	PC45d Self-strip module with Label Taken Sensor (LTS)
2	205-189-001	LABELS	PC45d Healthcare Self-strip module with Label Taken Sensor (LTS)

## PC45t Self Strip

To use the self strip accessory for printing, you print labels on self-adhesive label stock with a liner. As each label is printed, the label is automatically peeled from the liner and is presented at the front of the printer for manual removal.

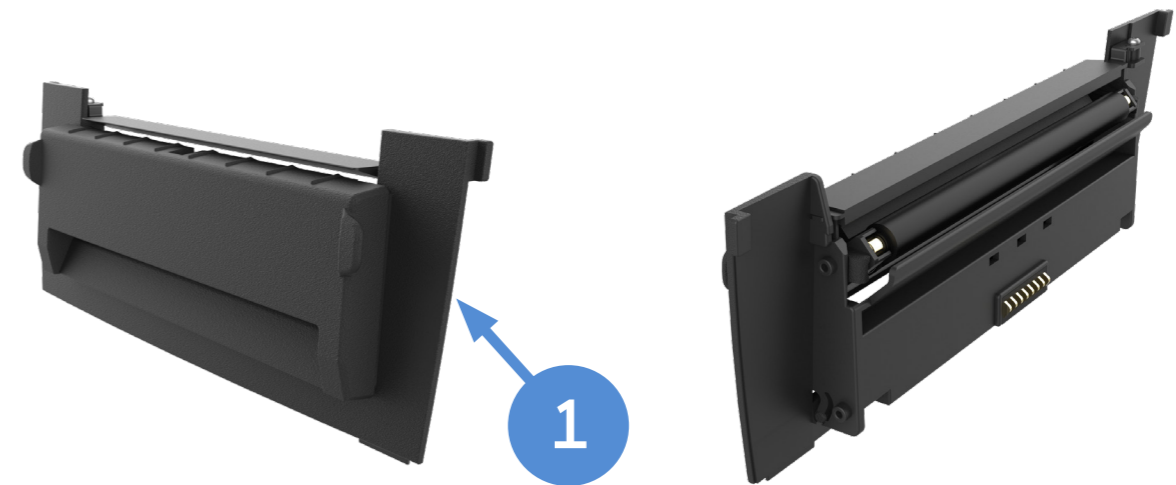

	PART NUMBER	MEDIA	DESCRIPTION
1	205-188-001	LABELS	PC45t Self-strip module with Label Taken Sensor (LTS)

# ACCESSORIES

## External Media Hanger

To use large rolls of media or tag stock, you can load the media from outside the printer.



PD45d

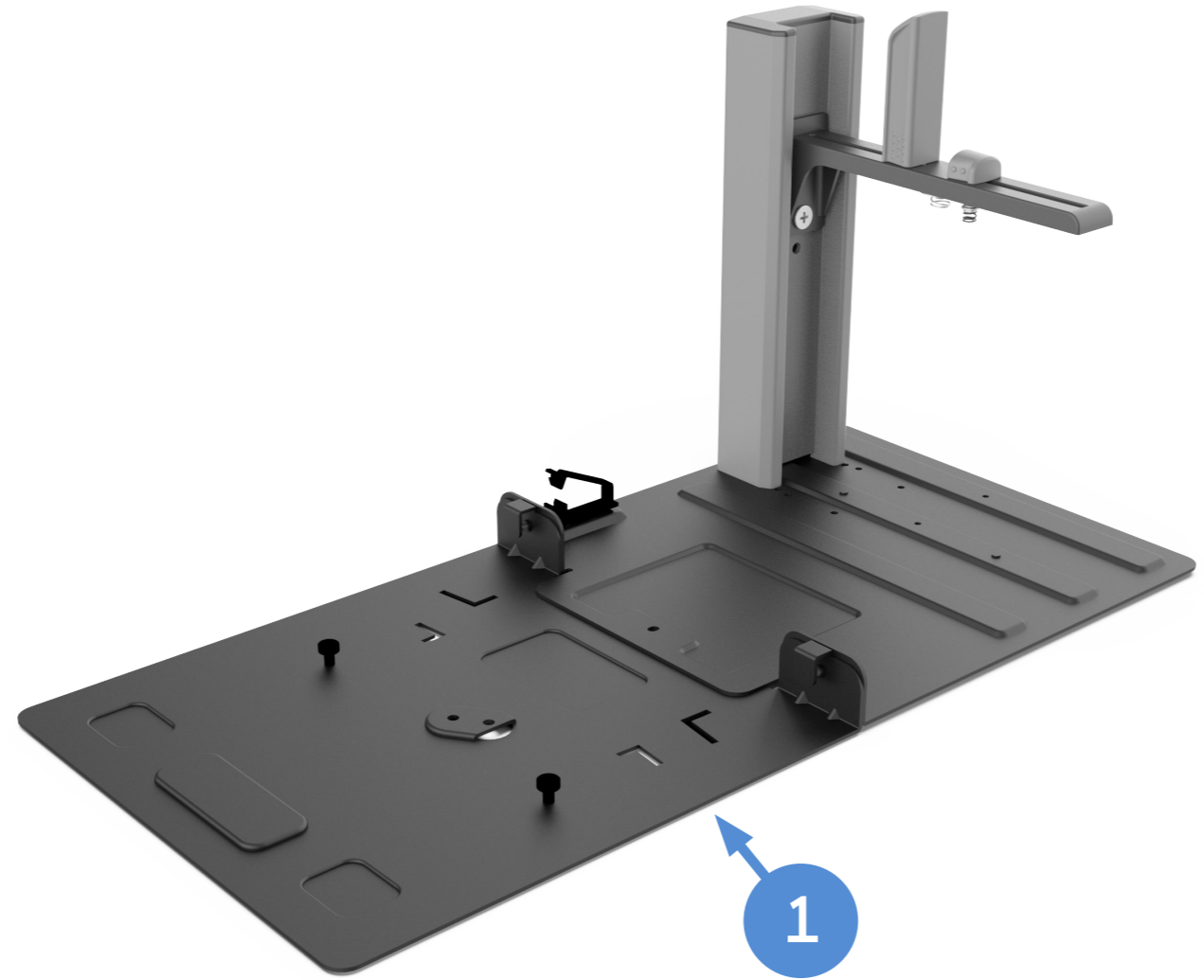

PC45t

1	PART NUMBER	DESCRIPTION
	205-190-005	External Media Holder

# ACCESSORIES

## Consumables and Cables

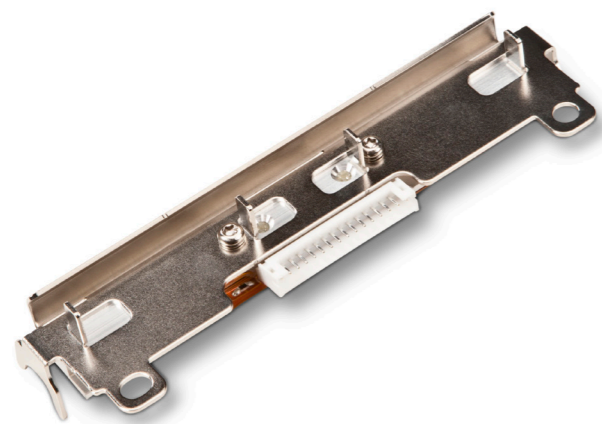

PART NUMBER	DESCRIPTION
225-783-001	PC45d/ PC45t 203 DPI Printhead Assembly, 4"
225-784-001	PC45d/ PC45t 300 DPI Printhead Assembly, 4"



PART NUMBER	DESCRIPTION
1-110501-00	Cleaning Card, 4.5"x6", box of 25



PART NUMBER	DESCRIPTION
203-188-200	Media Cover Lock



PART NUMBER	DESCRIPTION
205-187-002	PC45d Platen Roller

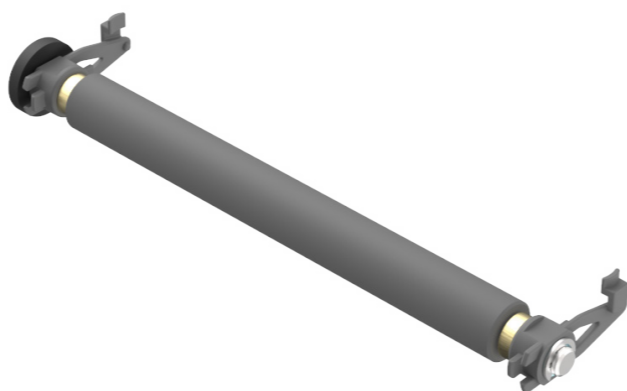

PART NUMBER	DESCRIPTION
205-187-003	PC45d Linerless Platen Roller

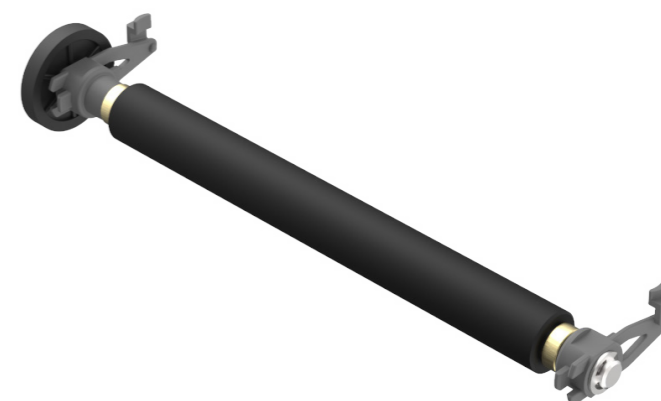

PART NUMBER	DESCRIPTION
205-188-002	PC45t Platen Roller

# ACCESSORIES

## Consumables and Cables



PART NUMBER	DESCRIPTION
321-576-004	USB (USB-A to USB-B) cable, 6.5 ft. (2 m) length



PART NUMBER	DESCRIPTION
203-182-100	USB to Serial Adapter - Cable length is 1.8 m (5.9 ft). Serial flow control: XON/XOFF, RTS/CTS.

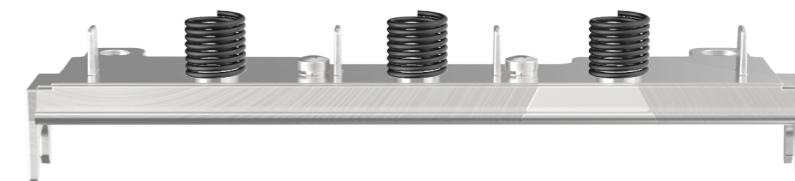

PART NUMBER	DESCRIPTION
213-004-004	Heavier spring kit for printhead to support thicker media (tag media). Printhead bracket not included.



PART NUMBER	DESCRIPTION
205-188-010	0.5 in Ribbon Core Adapters

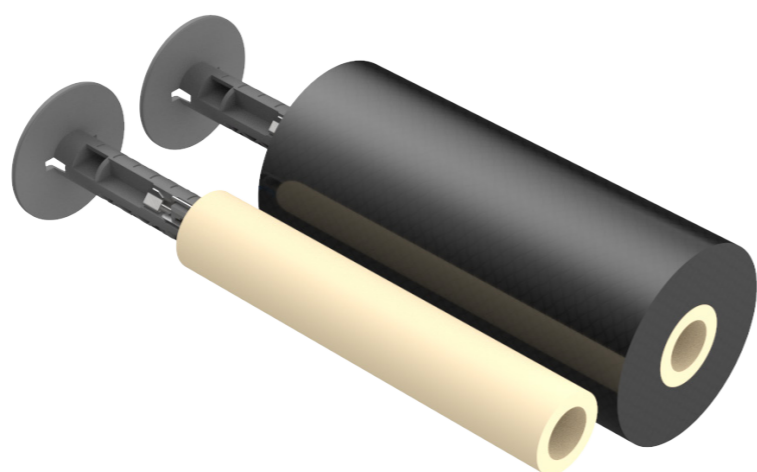

PART NUMBER	DESCRIPTION
205-188-009	1.0 in Ribbon Core Adapters

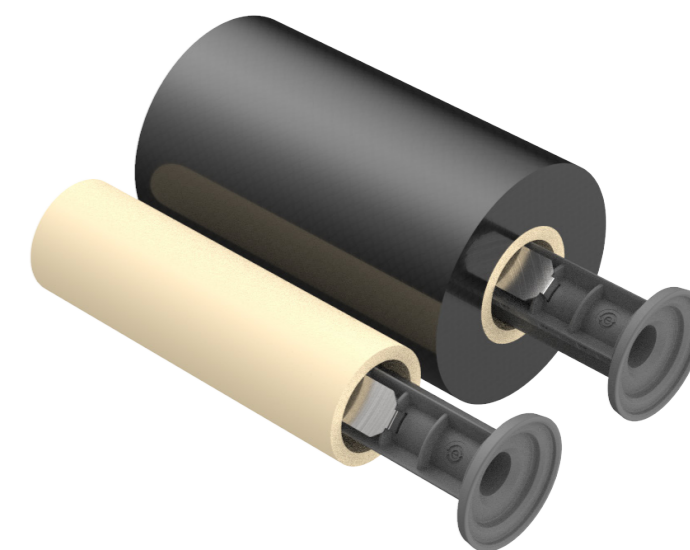
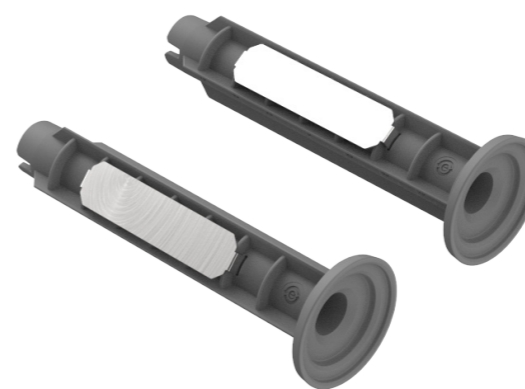

# MISCELLANEOUS

## Power Supply

Replacement Power Supply.



IEC C14



1

## AC Cords

Regional Power Cords



AC Power - C13 Type Connector

**PART NUMBER**      **DESCRIPTION**



















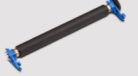

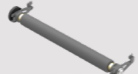

















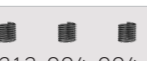
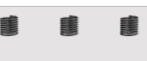

1      203-186-200      Universal Power Adapter 100V-240V AC input, All PC Series Printers

**PART NUMBER**      **TYPE**      **DESCRIPTION**

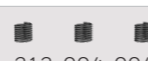
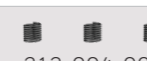
1-974030-025      C13      AC Power Cord, Australia RoHS  
 321-501-002      C13      AC Power Cord, Denmark RoHS  
 1-974027-025FRE      C13      FRE, AC Power Cord, Europe RoHS  
 321-502-002      C13      AC Power Cord, India/South Africa RoHS  
 321-471-002      C13      AC Power Cord, Italy RoHS  
 9000093CABLE      C13      AC POWER CABLE, C14 TYPE, SWITZERLAND 3-PIN  
 1-974029-020      C13      AC Power Cord, UK RoHS  
 1-974028-025      C13      AC Power Cord, US RoHS

# APPENDIX

## PC45 vs PC43 Accessories

ACCESSORIES										
Category	Description	 PC45d	 PC45d Healthcare	 PC45t	 PC43d	 PC43t	Is the PC45 part the same as PC43?	Is the PC43 part compatible with PC45?	Customer Installable	Notes
Platen Roller	Platen Roller Kit	 205-187-002	 205-187-002	 205-188-002	 910400025370	 910400024880	No	Yes	Yes	Colour change only.
	Linerless Platen Roller Kit	 205-187-003	 205-187-003	-	 203-185-400 225-783-001	 203-185-500 225-783-001	No	Yes	Yes	Colour change only.
Printheads	203 DPI Printhead Assembly, 4"	225-783-001	225-783-001	225-783-001	225-783-001	225-783-001	Yes	Yes	Yes	
	300 DPI Printhead Assembly, 4"	225-784-001	225-784-001	225-784-001	225-784-001	225-784-001	Yes	Yes	Yes	
Ribbon Adapters	0.5 inch Ribbon Adapters	-	-	 205-188-010	-	-	No	No	Yes	
	1.0 inch Ribbon Adapters	-	-	 205-188-009	-	 225-781-001	Yes	Yes	Yes	Colour change only.
Wi-Fi / Bluetooth	Kit, Wireless LAN, North America (NA)	205-190-011 (a/b/g/n/ac/ax)	205-190-011 (a/b/g/n/ac/ax)	205-190-011 (a/b/g/n/ac/ax)	50177263-001 (b/g/n)	50177263-001 (b/g/n)	No	No	Yes	
	Kit, Wireless LAN, Rest Of World (ROW)	205-190-012 (a/b/g/n/ac/ax)	205-190-012 (a/b/g/n/ac/ax)	205-190-012 (a/b/g/n/ac/ax)	203-183-420 (b/g/n) - Red PCB 203-183-420 (a/b/g/n) - Green PCB	203-183-420 (b/g/n) - Red PCB 203-183-420 (a/b/g/n) - Green PCB	No	No	Yes	
Label Dispenser	Self Strip (Label Dispenser)	 205-187-001	 205-189-001	 205-188-001	 203-184-410	 203-184-510	No	Yes	Yes	PC43 self strip is compatible with PC45.
Cutter	Cutter Kit	 205-187-006	-	 205-188-006	 203-184-420 203-184-423	 203-184-520 203-184-523	No	Yes	Yes	PC43 cutter can be used in PC45 but this will need the retract distance setting value changed.
	Linerless Cutter Kit	 205-187-004	-	-	-	-	No	Yes	Yes	PC43 cutter can be used in PC45 but this will need the retract distance setting value changed.
Cutter Tray	Cutter Tray	 205-187-001	-	 205-187-001	 203-188-100	 203-188-100	No	Yes	Yes	
Bases	Power Adapter Basebay	-	-	-	 203-187-410	-	No	No	Yes	Not supported on PC45.
	Battery Basebay	-	-	-	 203-187-420	 213-047-001	No	No	Yes	Not supported on PC45.
Springs	Heavy Duty Springs for Thicker Media	 213-004-004	 213-004-004	 213-004-004	 213-004-004	 213-004-004	Yes	Yes	Yes	
Media Lock	Media Lock	 203-188-200	 203-188-200	 203-188-200	 203-188-200	 203-188-200	Yes	Yes	Yes	

# APPENDIX

## Front Display - Compare PC45 to PC43

Compare the LCD/ Keyboard assembly.

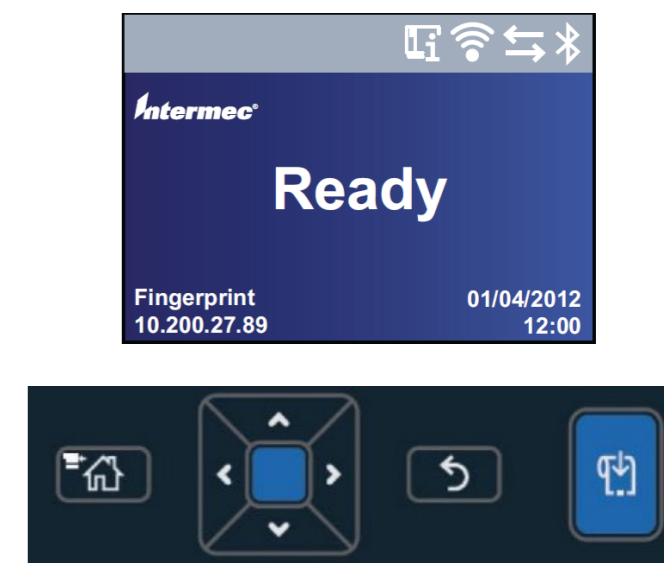
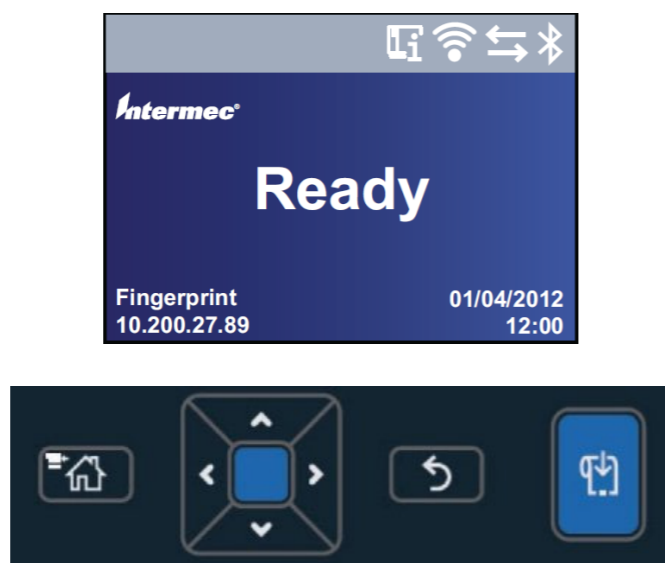

PC45d  
3.5 in LCD Full Touch



PC43d  
2.36 in LCD Non-Touch



PC45t  
3.5 in LCD Full Touch



PC43t  
2.36 in LCD Non-Touch

# APPENDIX

## Media Compartment - Compare PC45t to PC43t

Compare the media setup.

























PC43t



PC45t

# APPENDIX

## Connectivity - Compare PC45 to PC43

CONNECTIVITY					
	 <b>PC45d</b>	 <b>PC45d Healthcare</b>	 <b>PC45t</b>	 <b>PC43d</b>	 <b>PC43t</b>
<b>Communications</b>					
USB Host	Standard (1x USB-A Front, 1x USB-A Rear)	Standard (1x USB-A Front, 1x USB-A Rear)	Standard (1x USB-A Front, 1x USB-A Rear)	Standard (1x USB-A Front, 1x USB-A Rear)	Standard (1x USB-A Front, 1x USB-A Rear)
USB Client	Standard (1x USB-B Rear)	Standard (1x USB-B Rear)	Standard (1x USB-B Rear)	Standard (1x USB-B Rear)	Standard (1x USB-B Rear)
Serial	Optional / SKU Dependent  203-182-100 USB to Serial Cable	Optional / SKU Dependent  203-182-100 USB to Serial Cable	Optional / SKU Dependent  203-182-100 USB to Serial Cable	Optional  203-182-100 USB to Serial Cable	Optional  203-182-100 USB to Serial Cable
Parallel	Not supported	Not supported	Not supported	Optional  203-182-110 USB to Parallel Cable	Optional  203-182-110 USB to Parallel Cable
Ethernet	Standard	Standard	Standard	Optional / SKU Dependent  203-183-410 Ethernet Module	Optional / SKU Dependent  203-183-410 Ethernet Module
Wi-Fi / Bluetooth / Near Field Communication (NFC)	Optional / SKU Dependent  205-190-011 Wi-Fi/BT Module/ NFC 205-190-012 Wi-Fi/BT Module/ NFC	Optional / SKU Dependent  205-190-011 Wi-Fi/BT Module/ NFC 205-190-012 Wi-Fi/BT Module/ NFC	Optional / SKU Dependent  205-190-011 Wi-Fi/BT Module/ NFC 205-190-012 Wi-Fi/BT Module/ NFC	Optional / SKU Dependent  203-183-420 Wi-Fi/BT Module	Optional / SKU Dependent  203-183-420 Wi-Fi/BT Module
Apple iOS MFi Certification	Supported via Bluetooth, requires Wi-Fi / Bluetooth / Near Field Communication (NFC) card to be installed	Supported via Bluetooth, requires Wi-Fi / Bluetooth / Near Field Communication (NFC) card to be installed	Supported via Bluetooth, requires Wi-Fi / Bluetooth / Near Field Communication (NFC) card to be installed	Not supported	Not supported
4G LTE Cellular Modem	Optional  205-190-008 Cellular Modem	Optional  205-190-008 Cellular Modem	Optional  205-190-008 Cellular Modem	Not supported	Not supported

# MISCELLANEOUS

## Disclaimer

---

### Disclaimer

Honeywell International Inc. (“HII”) reserves the right to make changes in specification and other information contained in this document without prior notice, and the reader should in all cases consult HII to determine whether any such changes have been made. The information in this publication does not represent a commitment on the part of HII.

HII shall not be liable for technical or editorial errors or omissions contained herein; nor for incidental or consequential damages resulting the furnishing, performance, or use of this material.

This document contains proprietary information that is protected by copyright. All rights are reserved. No part of this document may be photocopied, reproduced, or translated into another language with-out prior written consent of HII.

Web Address: [www.honeywellaidc.com](http://www.honeywellaidc.com)

The Bluetooth trademarks are owned by Bluetooth SIG, Inc., U.S.A and licensed to Honeywell.

Apple, iOS, iPod touch and iPhone are trademarks of Apple Inc., registered in the U.S. and other countries. App Store is a service mark of Apple Inc.

Android is a trademark or registered trademark of Google Inc. in the United States and/or other countries. Windows is a trademark or registered trademark of Microsoft Corporation.

Other product names mentioned in the manual may be trademarks of registered trademarks of their respective companies and are the property of their respective owners.

All rights reserved.

### For more information

[sps.honeywell.com](http://sps.honeywell.com)

### Honeywell Safety and Productivity Solutions

300 S Tryon St Suite 500  
Charlotte, NC 28202  
800-582-4263  
[www.honeywell.com](http://www.honeywell.com)