

PD45 SERIES INDUSTRIAL PRINTER

Configuration Guide



PD45 ICON
2 - 8 IPS



PD45 2.36" LCD WITH KEYPAD
2 - 8 IPS



PD45S 2.36" LCD WITH KEYPAD
2 - 10 IPS



PD45S 3.5" FULL TOUCH LCD
2 - 10 IPS

THE
FUTURE
IS
WHAT
WE
MAKE IT

Honeywell

TABLE OF CONTENTS

- 1** **TABLE OF CONTENTS**
- 2** **PD45 SERIES**
COMPARE THE MODELS
- 3** **PD45 SERIES PRINTING OPTIONS**
- 4** **PD45 SERIES MEDIA**
SPECIFICATIONS
- 5** **PD45S FEATURE OVERVIEW**
PD45SOF - 3.5" FULL TOUCH DISPLAY
TEAR OFF - THERMAL TRANSFER
REWINDER + LABEL TAKEN SENSOR - THERMAL TRANSFER
PD45SOC - 2.36" LCD WITH KEYPAD
TEAR OFF - THERMAL TRANSFER
REWINDER + LABEL TAKEN SENSOR - THERMAL TRANSFER
- 9** **PD45 FEATURE OVERVIEW**
PD4500C - 2.36" LCD WITH KEYPAD - TEAR OFF - THERMAL TRANSFER
PD4500B - ICON - TEAR OFF - THERMAL TRANSFER
- 11** **PD45 SERIES CONFIGURATION MAP**
INDUSTRIAL PRINTER
- 12** **HONEYWELL EDGE SERVICES**
GOLD REPAIR SERVICES - 3 YEAR
PLATINUM REPAIR SERVICES - 3 YEAR
GOLD REPAIR SERVICES - 5 YEAR
PLATINUM REPAIR SERVICES - 5 YEAR
PD45/ PD45S- REPAIR SERVICES COVERAGE
- 15** **ACCESSORIES**
PD45S - I/O CARDS
PD4500C/ PD45S - WIFI CARD
PD4500C/ PD45S - CUTTER
- 18** **ACCESSORIES**
CONSUMABLES AND CABLES
- 19** **MISCELLANEOUS**
AC CORDS

PD45 SERIES

Compare the models



PD45

PD4500B - Icon

- Icon User Interface
- 203 DPI - 2-8 ips
- 300 DPI - 2-4 ips
- USB Only
- Does NOT support Serial, Ethernet or WiFi



PD45

PD4500C - 2.36" LCD with Keypad

- Color LCD Interface with Keypad
- 203 DPI - 2-8 ips
- 300 DPI - 2-4 ips
- USB, Serial and Ethernet
- Cutter (50178579-001)

Supported I/O Cards

- WiFi Interface
 - European Union (EU) (50180825-001)
 - North America (50180826-001)
 - Rest Of World (ROW) (50180177-001)



PD45S

PD45S0C - 2.36" LCD with Keypad

- Color LCD Interface with Keypad
- 203 DPI - 2-10 ips
- 300 DPI - 2-8 ips
- USB, Serial and Ethernet
- Label Taken Sensor + Peel Off
- Cutter (50178579-001)

Supported I/O Cards

- Parallel Interface (50151883-001)
- Industrial Interface (50151884-001)
- Applicator Interface (50151885-001)
- WiFi Interface
 - European Union (EU) (50180825-001)
 - North America (50180826-001)
 - Rest Of World (ROW) (50180177-001)



PD45S

PD45S0F - 3.5" Full Touch LCD

- Full Touch LCD
- 203 DPI - 2-10 ips
- 300 DPI - 2-8 ips
- USB, Serial and Ethernet
- Label Taken Sensor + Peel Off
- Cutter (50178579-001)

Supported I/O Cards

- Parallel Interface (50151883-001)
- Industrial Interface (50151884-001)
- Applicator Interface (50151885-001)
- WiFi Interface
 - European Union (EU) (50180825-001)
 - North America (50180826-001)
 - Rest Of World (ROW) (50180177-001)

PD45 SERIES PRINTING OPTIONS

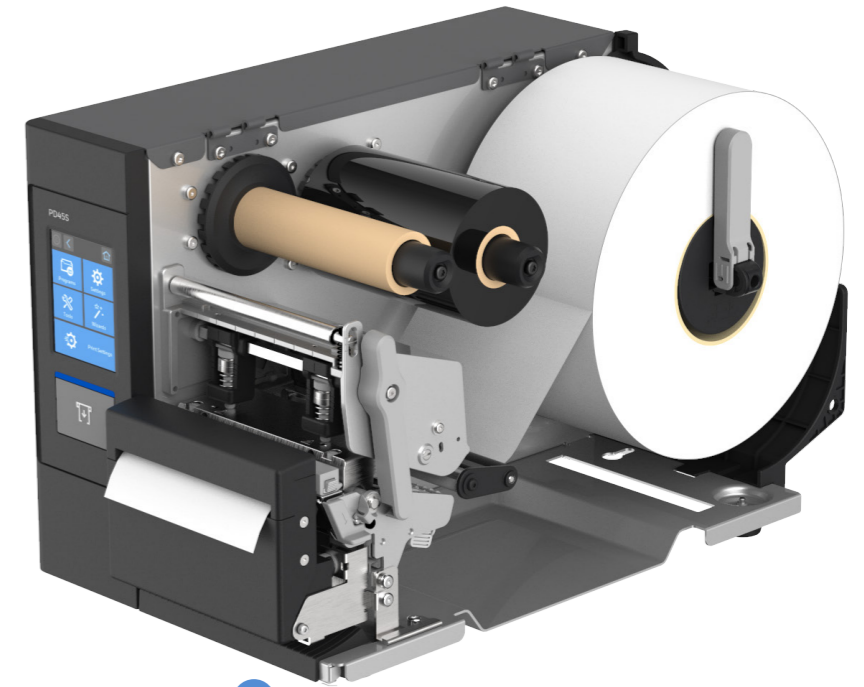
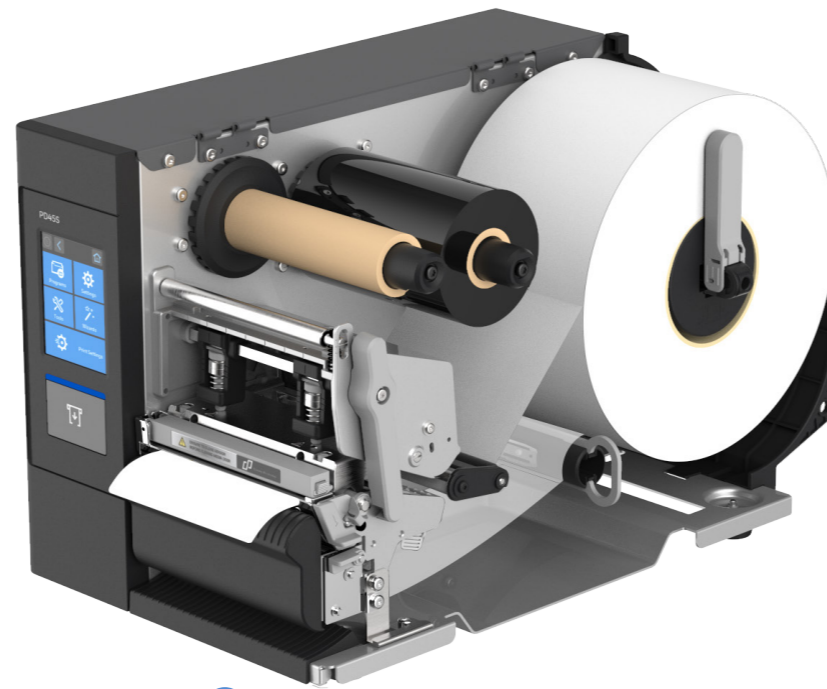
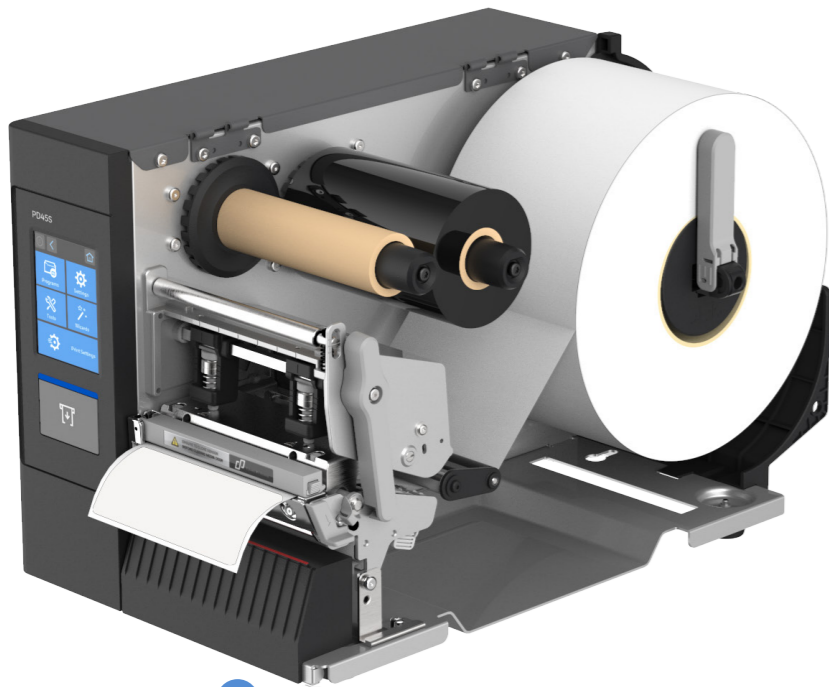

Tear Off

Most commonly used, print any number of labels and simply tear the labels off from the printer at the end of the print job. This method of printing is available on any PD45 or PD45S configuration.

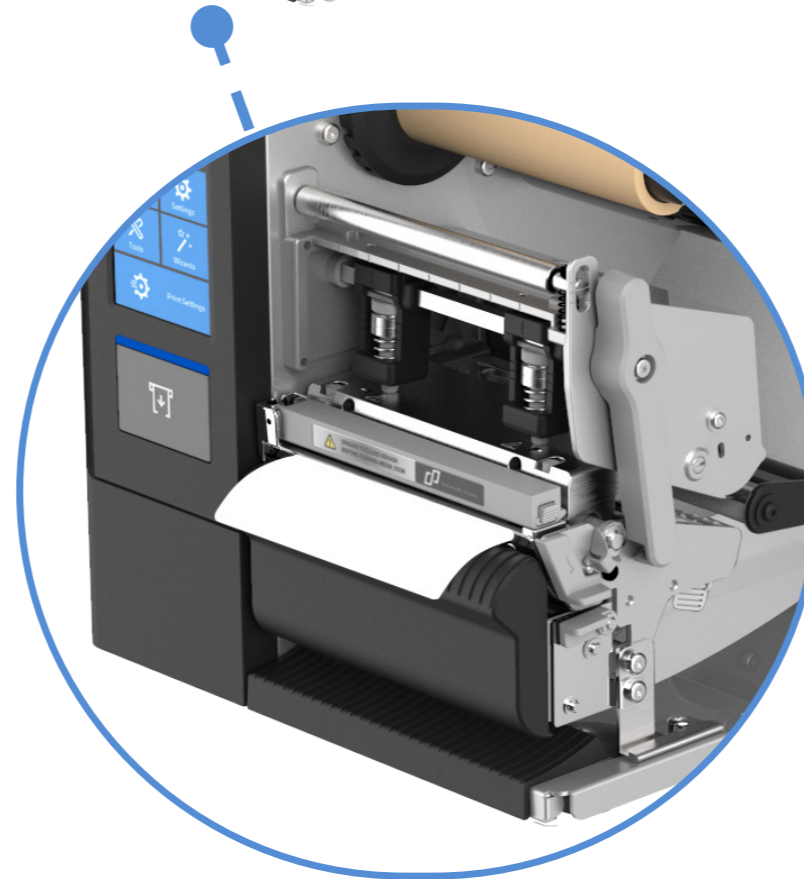

Peel & Present (Enhanced Self-Strip with Peel Off Kit)

Self-Strip prints and presents only one label at a time already peeled from the backing strip/ liner, the next label will only be printed once the original label is removed from the media path.

Must be ordered from factory, not field installable.

PD45Sxxxxxx2xxxx PD45S with Internal Rewind + LTS



Cutter

A cutter can be added to any configuration of PD45S, simply cutting between labels, or at intervals on continuous media. This method of printing is available on any PD45S configuration and PD4500C.

ID = Inside Diameter
 OD = Outside Diameter

PD45 SERIES MEDIA

Specifications

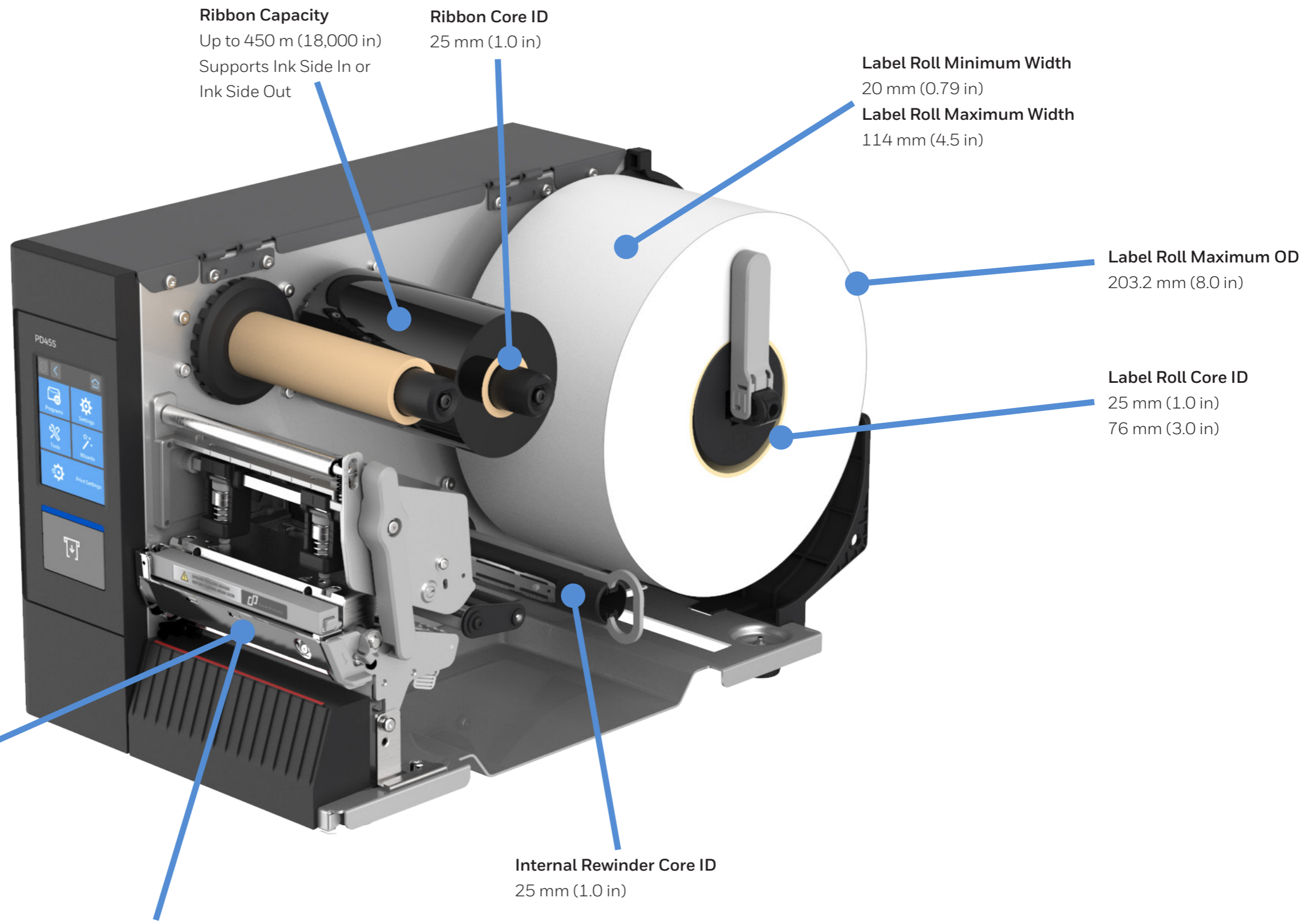

Maximum Print Width
 203 dpi: 108 mm (4.25 in)
 300 dpi: 105.7 mm (4.17 in)

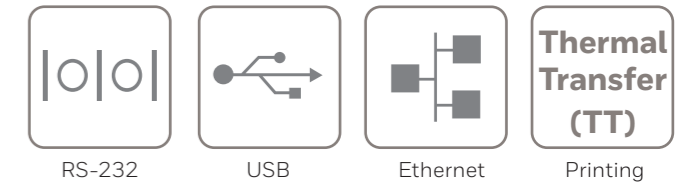

PD45S FEATURE OVERVIEW

PD45S0F - 3.5" Full Touch Display - Tear Off - Thermal Transfer



PD45S - 3.5" Full Touch - Thermal Transfer - 203 DPI

PD45S0F0010000200 PD45S, 3.5 inch Full Touch Display, 10ips, Ethernet, Fixed Hanger, Thermal Transfer (TT), 203 DPI, No Power Cord

PD45S - 3.5" Full Touch - Thermal Transfer - 300 DPI

PD45S0F0010000300 PD45S, 3.5 inch Full Touch Display, 8ips, Ethernet, Fixed Hanger, Thermal Transfer (TT), 300 DPI, No Power Cord

Included in the box:

- PD45S
- PD45 Series Regulatory Sheet (PD45-ML-RS-03)
- No Power Cord
- Ribbon Core (50121729-001)
- Media Guide (3008-4359-001)

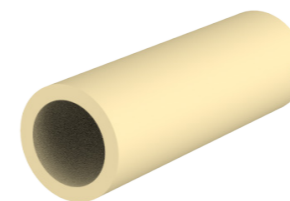

Note: Not all printer combinations are available in every region. Check your local Price Book to see which part numbers are available for sale.

Honeywell Repair Services

SVC PD45S-SG3N	PD45S, Edge Service, Gold Maintenance Contract, 3 Year, New Contract
ADD SVCPRINTHEAD-PRN3	AddOn, Edge Service, Printhead Refresh Service, 203 or 300 DPI, 3-Year Contract
ADD SVCACC-PRN3	AddOn, Edge Service, Accessory Service, Printer, 3 Year

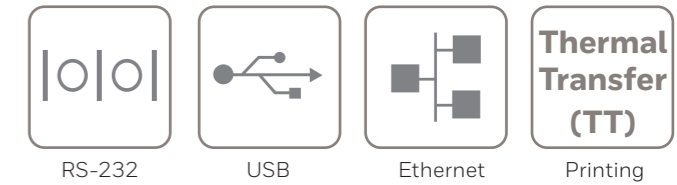

PD45S FEATURE OVERVIEW

PD45S0F - 3.5" Full Touch Display - Rewinder + Label Taken Sensor - Thermal Transfer



PD45S - 3.5" Full Touch - Internal Rewind + Label Taken Sensor - Thermal Transfer - 203 DPI

PD45S0F0010020200 PD45S, 3.5 inch Full Touch Display, 10ips, Ethernet, Fixed Hanger, Rewinder + Label Taken Sensor + Peel Off, Thermal Transfer (TT), 203 DPI, No Power Cord

PD45S - 3.5" Full Touch - Internal Rewind + Label Taken Sensor - Thermal Transfer - 300 DPI

PD45S0F0010020300 PD45S, 3.5 inch Full Touch Display, 8ips, Ethernet, Fixed Hanger, Rewinder + Label Taken Sensor + Peel Off, Thermal Transfer (TT), 300 DPI, No Power Cord

Included in the box:

- PD45S
- PD45 Series Regulatory Sheet (PD45-ML-RS-03)
- No Power Cord
- Ribbon Core (50121729-001)
- Media Guide (3008-4359-001)

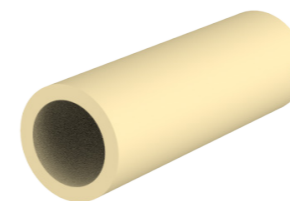

Note: Not all printer combinations are available in every region. Check your local Price Book to see which part numbers are available for sale.

Honeywell Repair Services

SVC PD45S-SG3N	PD45S, Edge Service, Gold Maintenance Contract, 3 Year, New Contract
ADD SVCPRINTHEAD-PRN3	AddOn, Edge Service, Printhead Refresh Service, 203 or 300 DPI, 3-Year Contract
ADD SVCACC-PRN3	AddOn, Edge Service, Accessory Service, Printer, 3 Year

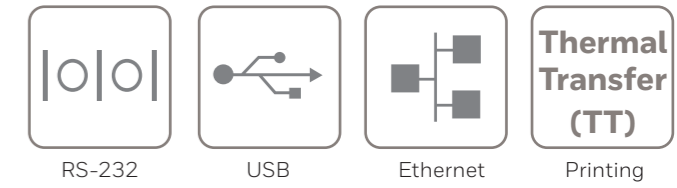

PD45S FEATURE OVERVIEW

PD45S0C - 2.36" LCD with Keypad - Tear Off - Thermal Transfer



PD45S - 2.36" LCD with Keypad - Thermal Transfer - 203 DPI

PD45S0C0010000200

PD45S, 2.36 inch Display with Keypad, 10ips, Ethernet, Fixed Hanger, Thermal Transfer (TT), 203 DPI, No Power Cord

PD45S - 2.36" LCD with Keypad - Thermal Transfer - 300 DPI

PD45S0C0010000300

PD45S, 2.36 inch Display with Keypad, 8ips, Ethernet, Fixed Hanger, Thermal Transfer (TT), 300 DPI, No Power Cord

Included in the box:

- PD45S
- PD45 Series Regulatory Sheet (PD45-ML-RS-03)
- No Power Cord
- Ribbon Core (50121729-001)
- Media Guide (3008-4359-001)

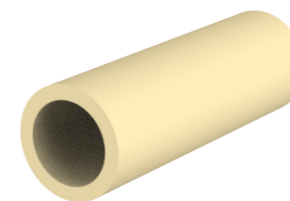

Note: Not all printer combinations are available in every region. Check your local Price Book to see which part numbers are available for sale.

Honeywell Repair Services

SVCPD45S-SG3N

PD45S, Edge Service, Gold Maintenance Contract, 3 Year, New Contract

ADD SVCPRINTHEAD-PRN3

AddOn, Edge Service, Printhead Refresh Service, 203 or 300 DPI, 3-Year Contract

ADD SVCACC-PRN3

AddOn, Edge Service, Accessory Service, Printer, 3 Year

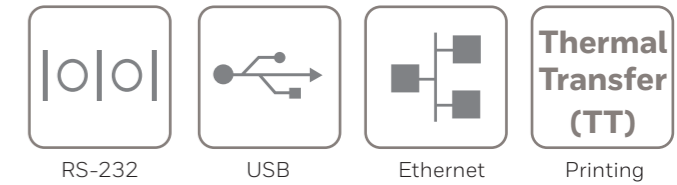

PD45S FEATURE OVERVIEW

PD45S0C - 2.36" LCD with Keypad - Rewinder + Label Taken Sensor - Thermal Transfer



PD45S - 2.36" LCD with Keypad - Internal Rewind + Label Taken Sensor - Thermal Transfer - 203 DPI

PD45S0C0010020200 PD45S, 2.36 inch Display with Keypad, 10ips, Ethernet, Fixed Hanger, Rewinder + Label Taken Sensor + Peel Off, Thermal Transfer (TT), 203 DPI, No Power Cord

PD45S - 2.36" LCD with Keypad - Internal Rewind + Label Taken Sensor - Thermal Transfer - 300 DPI

PD45S0C0010020300 PD45S, 2.36 inch Display with Keypad, 8ips, Ethernet, Fixed Hanger, Rewinder + Label Taken Sensor + Peel Off, Thermal Transfer (TT), 300 DPI, No Power Cord

Included in the box:

- PD45S
- PD45 Series Regulatory Sheet (PD45-ML-RS-03)
- No Power Cord
- Ribbon Core (50121729-001)
- Media Guide (3008-4359-001)

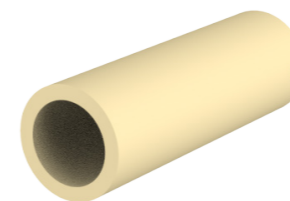

Note: Not all printer combinations are available in every region. Check your local Price Book to see which part numbers are available for sale.

Honeywell Repair Services

SVC PD45S-SG3N	PD45S, Edge Service, Gold Maintenance Contract, 3 Year, New Contract
ADD SVCPRINHEAD-PRN3	AddOn, Edge Service, Printhead Refresh Service, 203 or 300 DPI, 3-Year Contract
ADD SVCACC-PRN3	AddOn, Edge Service, Accessory Service, Printer, 3 Year

PD45 FEATURE OVERVIEW

PD4500C - 2.36" LCD with Keypad - Tear Off - Thermal Transfer

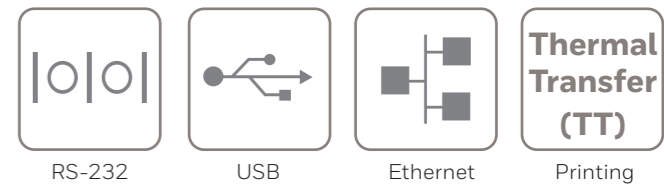

PD45 - 2.36" LCD with Keypad - Thermal Transfer - 203 DPI

PD4500C0010000200

PD45, 2.36 inch Display with Keypad, 8ips, Ethernet, Fixed Hanger, Thermal Transfer (TT), 203 DPI, No Power Cord

PD45 - 2.36" LCD with Keypad - Thermal Transfer - 300 DPI

PD4500C0010000300

PD45, 2.36 inch Display with Keypad, 4ips, Ethernet, Fixed Hanger, Thermal Transfer (TT), 300 DPI, No Power Cord

Included in the box:

- PD45
- PD45 Series Regulatory Sheet (PD45-ML-RS-03)
- No Power Cord
- Ribbon Core (50121729-001)

- Media Guide (3008-4359-001)

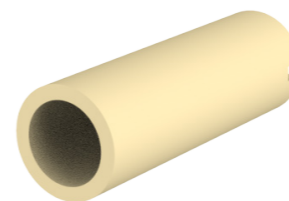

Note: Not all printer combinations are available in every region. Check your local Price Book to see which part numbers are available for sale.

Honeywell Repair Services

SVCPD45-SG3N

PD45, Edge Service, Gold Maintenance Contract, 3 Year, New Contract

ADD SVCPRINTHEAD-PRN3

AddOn, Edge Service, Printhead Refresh Service, 203 or 300 DPI, 3-Year Contract

ADD SVCACC-PRN3

AddOn, Edge Service, Accessory Service, Printer, 3 Year

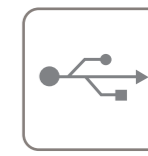

USB

Printing

PD45 FEATURE OVERVIEW

PD4500B - Icon - Tear Off - Thermal Transfer



PD45 - Icon - Thermal Transfer - 203 DPI

PD4500B0030000200 PD45, Icon, 8ips, USB Only, Fixed Hanger, Thermal Transfer (TT), 203 DPI, No Power Cord

PD45 - Icon - Thermal Transfer - 300 DPI

PD4500B0030000300 PD45, Icon, 4ips, USB Only, Fixed Hanger, Thermal Transfer (TT), 300 DPI, No Power Cord

Included in the box:

- PD45
- PD45 Series Regulatory Sheet (PD45-ML-RS-03)
- No Power Cord
- Ribbon Core (50121729-001)

- Media Guide (3008-4359-001)

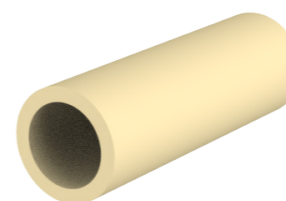

Note: Not all printer combinations are available in every region. Check your local Price Book to see which part numbers are available for sale.

Honeywell Repair Services

SVCPD45-SG3N PD45, Edge Service, Gold Maintenance Contract, 3 Year, New Contract

ADD SVCPRINHEAD-PRN3 AddOn, Edge Service, Printhead Refresh Service, 203 or 300 DPI, 3-Year Contract

ADD SVCACC-PRN3 AddOn, Edge Service, Accessory Service, Printer, 3 Year

PD45 SERIES CONFIGURATION MAP

Industrial Printer

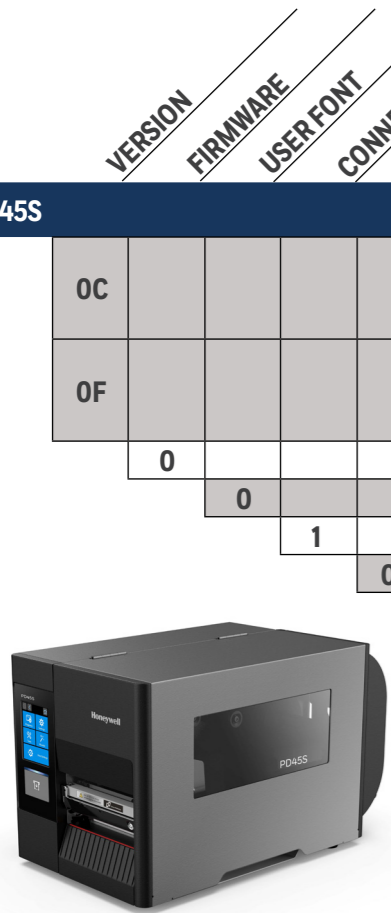

VERSION	FIRMWARE	USER FONT	CONNECTIVITY	I/O OPTION	OPTION	APPLICATIONS	PRINT OPTION	POWER CORD	DESCRIPTION	NOTES
PD45S										
									2.36" LCD with Keypad	User Interface Languages: English, Italian, French, Spanish, Portuguese, German, Russian, Traditional Chinese, Simplified Chinese, Korean, Japanese and Thai Print Speed: 203 DPI 2-10 inches per second (ips) / 300 DPI 2-8 inches per second (ips) Supports Parallel Interface (50151883-001), Industrial Interface (50151884-001), Applicator Interface (50151885-001)
									3.5" LCD Full Touch	User Interface Languages: English, Italian, French, Spanish, Portuguese, German, Russian, Traditional Chinese, Simplified Chinese, Korean, Japanese and Thai Print Speed: 203 DPI 2-10 inches per second (ips) / 300 DPI 2-8 inches per second (ips) Supports Parallel Interface (50151883-001), Industrial Interface (50151884-001), Applicator Interface (50151885-001)
	0								Universal Firmware	Fingerprint (FP), Direct Protocol (DP), IPL, ZSim2 (ZPL-II), DPL; XML can be enabled for SAP All and Oracle WMS
		0							Universal Font	Monotype font engine; non-Latin fonts can be supported through WTLE, and customers can also download (TrueType) fonts by themselves.
			1						Ethernet	1 x USB A Port (USB 2.0 Host), 1 x USB B Port (USB 2.0 Device), 1 x DB9F (RS-232, up to 115.2 KB/s), Ethernet 10/100/1000 Mbps
				00					None	
					0				None	
						2			Rewinder + Label Taken Sensor (LTS) + Peel Off	
							0		Fixed Hanger	
							20		Thermal Transfer (TT) 203 DPI	Available as Kit - Part# 50177476-001 KIT, PRINTHEAD 203 DPI PX240S/PD45S
							30		Thermal Transfer (TT) 300 DPI	Available as Kit - Part# 50178575-001 KIT, PRINTHEAD 300DPI PX240S/PD45S
								0	None	AC Power Cord C13 Type Connector
								5	India Power Cord	AC Power Cord C13 Type Connector

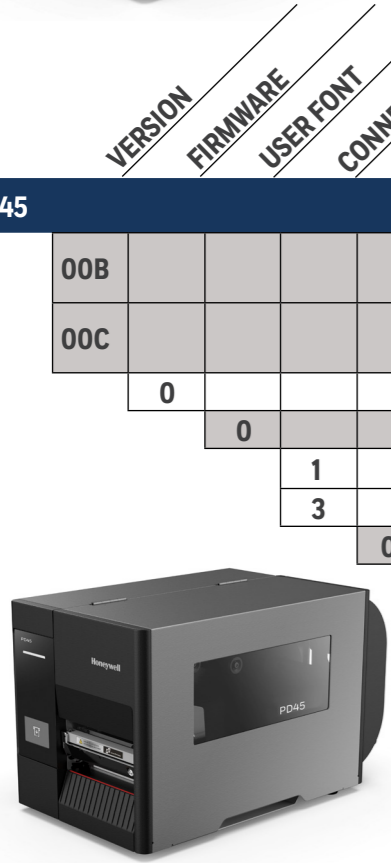

VERSION	FIRMWARE	USER FONT	CONNECTIVITY	I/O OPTION	OPTION	APPLICATIONS	PRINT OPTION	POWER CORD	DESCRIPTION	NOTES
PD45										
									Icon	No Display Print Speed: 203 DPI 2-8 inches per second (ips) / 300 DPI 2-4 inches per second (ips)
									2.36" LCD with Keypad	User Interface Languages: English, Italian, French, Spanish, Portuguese, German, Russian, Traditional Chinese, Simplified Chinese, Korean, Japanese and Thai Print Speed: 203 DPI 2-8 inches per second (ips) / 300 DPI 2-4 inches per second (ips)
	0								Universal Firmware	Fingerprint (FP), Direct Protocol (DP), IPL, ZSim2 (ZPL-II), DPL; XML can be enabled for SAP All and Oracle WMS
		0							Universal Font	Monotype font engine; non-Latin fonts can be supported through WTLE, and customers can also download (TrueType) fonts by themselves.
			1						Ethernet	1 x USB A Port (USB 2.0 Host), 1 x USB B Port (USB 2.0 Device), 1 x DB9F (RS-232, up to 115.2 KB/s), Ethernet 10/100/1000 Mbps
				3					USB Only	1 x USB A Port (USB 2.0 Host), 1 x USB B Port (USB 2.0 Device)
					00				None	
						0			None	
							0		Fixed Hanger	
							20		Thermal Transfer (TT) 203 DPI	Available as Kit - Part# 50178577-001 KIT, PRINTHEAD 203DPI PX240/PD45
							30		Thermal Transfer (TT) 300 DPI	Available as Kit - Part# 50178578-001 KIT, PRINTHEAD 300DPI PX240/PD45
								0	None	AC Power Cord C13 Type Connector
								5	India Power Cord	AC Power Cord C13 Type Connector

HONEYWELL EDGE SERVICES

PD45 / PD45S – Repair Services

Honeywell Edge Services give you the confidence of having leading-class technologies combined with service and support plans that are designed to keep you operational for longer.

Gold Repair Services – 3 Year

The most flexible contract in the industry. The Edge Services Gold Support contract allows you to select the right coverage for your organization, including 5-Day Depot Repairs and:

Service Overview

- Repair or replacement of damaged components, wear and tear, and accidental damage.
- Flexibility to add any Add-On Service

PART NUMBER	DESCRIPTION
SVCPD45-SG3N	PD45, Edge Service, GOLD Maintenance Contract, 5 Day Turnaround, 3 Year , New Contract
SVCPD45S-SG3N	PD45S, Edge Service, GOLD Maintenance Contract, 5 Day Turnaround, 3 Year , New Contract

Add-On Accessory Replacement Service

Provides replacement cables, interface cards or platen rollers should they be damaged or stop working.

ADD SVCACC-PRN3	AddOn, Edge Service, Accessory Service , Printer, 3 Year
------------------------	---

Add-On Printhead Refresh Service

Provides replacement 203 or 300 DPI printhead at 18 months after purchase.

ADD SVCPRINTHEAD-PRN3	AddOn, Edge Service, Printhead Refresh Service, 200 or 300 dpi, 3 Year , 1 replacement printhead
------------------------------	---

Add-On Device Replacement Service

Replacement devices should a device be damaged beyond repair.

ADD SVCREPLACE-PRN3	AddOn, Edge Service, Device Replacement, Printer, 3 Year
----------------------------	---

Add-On Cutter Replacement Service

Provides replacement cutters should they be damaged or stop working.

ADD SVCCUTTER1-PRN3	AddOn, Edge Service, Cutter Service for Printers, 3 Year
----------------------------	---

Add-On Spare Management Service

Manages every aspect of your spare pool.

ADD SVCSPAREMGMT-PRN3	AddOn, Edge Service, Advanced Exchange, Printer, 3 Year . Customer owned spare pool, Minimum Purchase required, contact your local Honeywell Service Representative for more information.
------------------------------	--

Add-On 2-Day Turnaround Depot Upgrade

Upgrade your Gold Maintenance Contract from 5-Day to 2-Day turnaround at the repair depot.

ADD SVC2DAYDEPOT-PRN3	AddOn, Edge Service, 2-Day Depot Upgrade, 3-Year Agreement, Requires purchase of a 3 Year Gold Maintenance Contract.
------------------------------	---

Platinum Repair Services – 3 Year

The Edge Services Platinum Support contract is the only total support contract in the industry today offering 2-Day Depot Repairs or Spare Pool Management with 3-year contract, that includes:

Service Overview

- Repair or replacement of damaged components
- SVCREPLACE-PRN3 - Replacement devices should a device be damaged beyond repair
- SVCACC-PRN3 - Accessory replacement service
- SVCPRINTHEAD-PRN3 - Provides replacement 203 or 300 DPI printhead at 18 months after purchase.
- SVCSPAREMGMT-PRN3 - Spare pool management (optional, minimum quantity required)
- SVCCUTTER1-PRN3 - Provides replacement cutters should they be damaged or stop working.
- Telephone-based technical support

PART NUMBER	DESCRIPTION
SVCPD45-SP3N	PD45, Edge Service, PLATINUM, 2 Day Turnaround, 3 Year, New Contract
SVCPD45S-SP3N	PD45S, Edge Service, PLATINUM, 2 Day Turnaround, 3 Year, New Contract



HONEYWELL EDGE SERVICES

PD45 / PD45S – Repair Services

Honeywell Edge Services give you the confidence of having leading-class technologies combined with service and support plans that are designed to keep you operational for longer.

Gold Repair Services – 5 Year

The most flexible contract in the industry. The Edge Services Gold Support contract allows you to select the right coverage for your organization, including 5-Day Depot Repairs and:

Service Overview

- Repair or replacement of damaged components, wear and tear, and accidental damage.
- Flexibility to add any Add-On Service

PART NUMBER	DESCRIPTION
SVCPD45-SG5N	PD45, Edge Service, GOLD Maintenance Contract, 5 Day Turnaround, 5 Year , New Contract
SVCPD45S-SG5N	PD45S, Edge Service, GOLD Maintenance Contract, 5 Day Turnaround, 5 Year , New Contract

Add-On Accessory Replacement Service

Provides replacement cables, interface cards or platen rollers should they be damaged or stop working.

ADD SVCACC-PRN5	AddOn, Edge Service, Accessory Service , Printer, 5 Year
------------------------	---

Add-On Printhead Refresh Service

Provides replacement 203 or 300 DPI printhead at 18 and 36 months after purchase.

ADD SVCPRINTHEAD-PRN5	AddOn, Edge Service, Printhead Refresh Service, 200 or 300 dpi, 5 Year , 2 replacement printheads
------------------------------	--

Add-On Device Replacement Service

Replacement devices should a device be damaged beyond repair.

ADD SVCREPLACE-PRN5	AddOn, Edge Service, Device Replacement, Printer, 5 Year
----------------------------	---

Add-On Cutter Replacement Service

Provides replacement cutters should they be damaged or stop working.

ADD SVCCUTTER1-PRN5	AddOn, Edge Service, Cutter Service for Printers, 5 Year
----------------------------	---

Add-On Spare Management Service

Manages every aspect of your spare pool.

ADD SVCSPAREMGMT-PRN5	AddOn, Edge Service, Advanced Exchange, Printer, 5 Year . Customer owned spare pool, Minimum Purchase required, contact your local Honeywell Service Representative for more information.
------------------------------	--

Add-On 2-Day Turnaround Depot Upgrade

Upgrade your Gold Maintenance Contract from 5-Day to 2-Day turnaround at the repair depot.

ADD SVC2DAYDEPOT-PRN5	AddOn, Edge Service, 2-Day Depot Upgrade, 3-Year Agreement, Requires purchase of a 5 Year Gold Maintenance Contract.
------------------------------	---

Platinum Repair Services – 5 Year

The Edge Services Platinum Support contract is the only total support contract in the industry today offering 2-Day Depot Repairs or Spare Pool Management with 5-year contract, that includes:

Service Overview

- Repair or replacement of damaged components
- SVCREPLACE-PRN5 - Replacement devices should a device be damaged beyond repair
- SVCACC-PRN5 - Accessory replacement service
- SVCPRINTHEAD-PRN5 - Provides replacement 203 or 300 DPI printhead at 18 and 36 months after purchase.
- SVCSPAREMGMT-PRN5 - Spare pool management (optional, minimum quantity required)
- SVCCUTTER1-PRN5 - Provides replacement cutters should they be damaged or stop working.
- Telephone-based technical support

PART NUMBER	DESCRIPTION
SVCPD45-SP5N	PD45, Edge Service, PLATINUM, 2 Day Turnaround, 5 Year, New Contract
SVCPD45S-SP5N	PD45S, Edge Service, PLATINUM, 2 Day Turnaround, 5 Year, New Contract



HONEYWELL REPAIR SERVICES

PD45/ PD45S- Repair Services Coverage

For Best-In-Class Service



PD45



PD45S

Warranty Cover Against Product Defect

BASIC Service

Gold Coverage:

- Accidental Damage
- Wear & Tear

Includes Replacement of:

- Platen Roller



Flexible GOLD Add-Ons ordered separately

- SVCACC-PRN3 Accessories
- SVCPRINHEAD-PRN3 Printhead Replacement
- SVCREPLACE-PRN3 Device Replacement
- SVCCUTTER1-PRN3 Cutter Replacement
- SVCSPAREMGMT-PRN3 Advanced Exchange

GOLD Service

Platinum Coverage

- Printhead Replacement
- Coverage for Cables and Interface Cards
- Cutter Replacement

- Accidental Damage
- Device Replacement
- Wear & Tear



Printhead
(3 Year – 1 replacement printhead)
(5 Year – 2 replacement printheads)



Cutter



I/O Cards

PLATINUM Service

MODEL	COVERAGE	PART NUMBER	DESCRIPTION
PD45	BASIC	SVCPD45-EXW3	PD45, BASIC, 10-15 Day Turnaround, 3 Years (1 Year Factory Warranty + 2 Years Extended)
PD45S	BASIC	SVCPD45S-EXW3	PD45S, BASIC, 10-15 Day Turnaround, 3 Years (1 Year Factory Warranty + 2 Years Extended)
PD45	GOLD	SVCPD45-SG3N	PD45, Edge Service, GOLD Maintenance Contract, 5 Day Turnaround, 3 Year, New Contract
PD45S	GOLD	SVCPD45S-SG3N	PD45S, Edge Service, GOLD Maintenance Contract, 5 Day Turnaround, 3 Year, New Contract
	ADD	SVCACC-PRN3	AddOn, Edge Service, Accessory Service, Printer, 3 Year.
	ADD	SVCPRINHEAD-PRN3	AddOn, Edge Service, 203 or 300 DPI Printhead Refresh Service, 3-Year Contract, 1 replacement printhead
	ADD	SVCREPLACE-PRN3	AddOn, Edge Service, Device Replacement, Printer, 3 Year
	ADD	SVCCUTTER1-PRN3	AddOn, Edge Service, Cutter Service for Printers, 3-Year
PD45	PLATINUM	SVCPD45-SP3N	PD45, Edge Service, PLATINUM, 2 Day Turnaround, 3 Year, New Contract
PD45S	PLATINUM	SVCPD45S-SP3N	PD45S, Edge Service, PLATINUM, 2 Day Turnaround, 3 Year, New Contract

ACCESSORIES

PD45S - I/O Cards

Expand your I/O with additional interface cards.

Warning: The I/O Cards must only be installed by an authorized service technician, as you need to open the printer and physically install the cards in the printer.

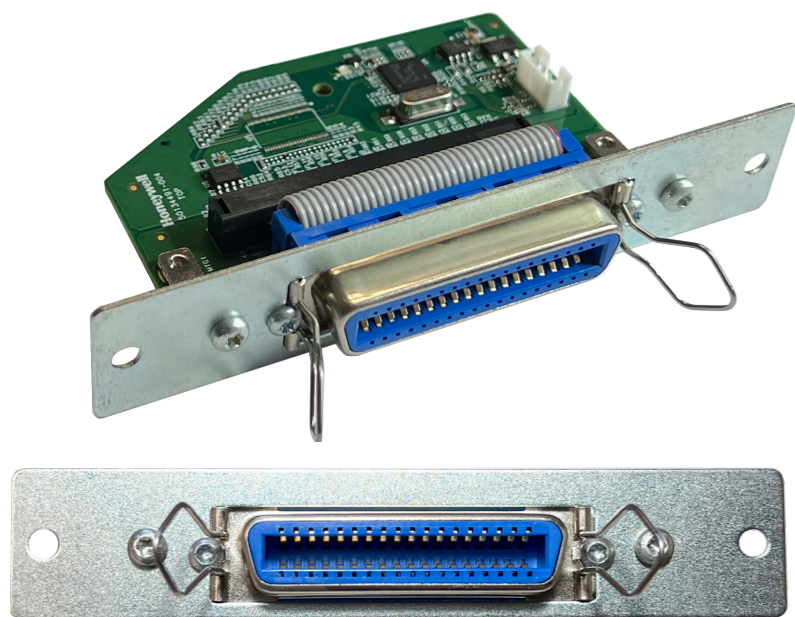

PART NUMBER	DESCRIPTION
50180156-001	KIT, PARALLEL PORT PD45S Use with Part# 1-974022-018 Parallel Cable



PD45S has 2 x I/O Expansion Slots

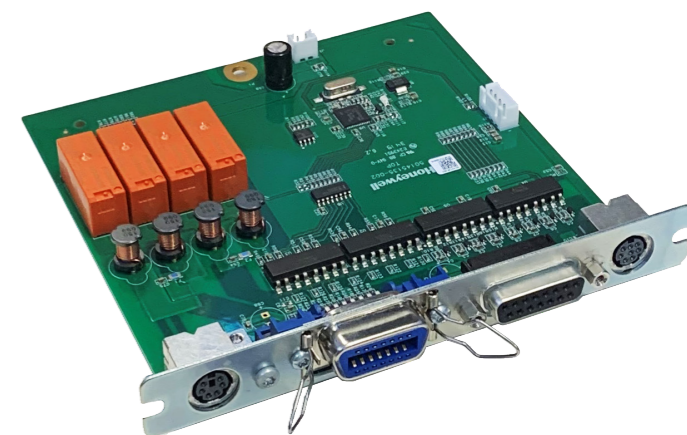

PART NUMBER	DESCRIPTION
50180158-001	APPLICATOR INTERFACE PD45S

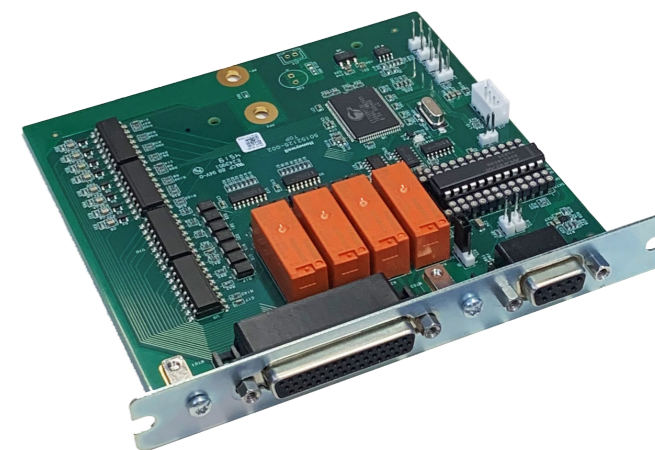

PART NUMBER	DESCRIPTION
50180157-001	UART + INDUSTRIAL INTERFACE PD45S

ACCESSORIES

PD4500C/ PD45S - WiFi Card

The WiFi can be easily added to any PD4500C or PD45S printer.



PART NUMBER	REGION	DESCRIPTION
50180826-001	North America	WiFi 802.11 a/b/g/n/ac PD45S/PD4500C Kit (Canada, Mexico, USA)
50180825-001	Multiple	WiFi 802.11 a/b/g/n/ac PD45S/PD4500C Kit (Australia, India, Israel, New Zealand, Russia, Singapore, South Africa, Thailand, Turkey)
50180177-001	Rest Of World	WiFi 802.11 a/b/g/n/ac PD45S/PD4500C Kit (Brazil)

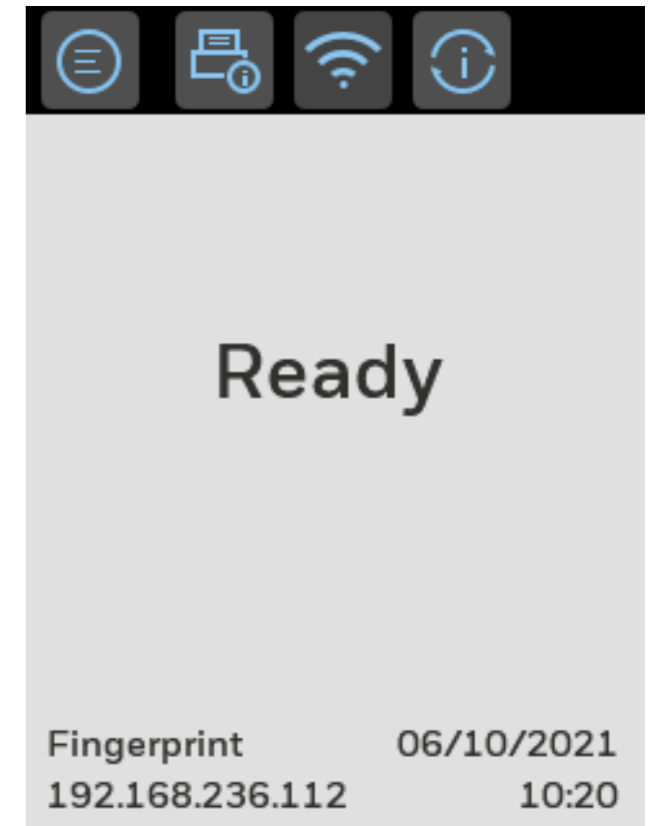

PD45S Rear I/O View

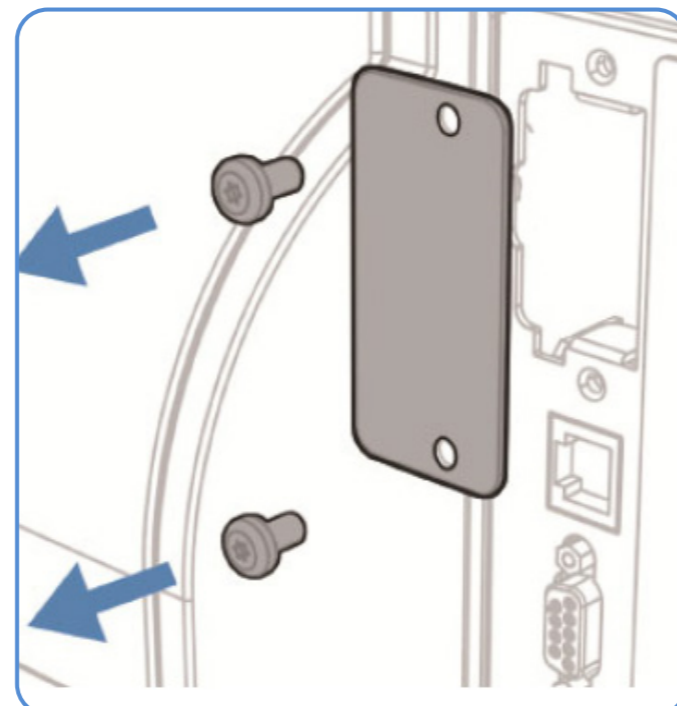

Remove cover plate

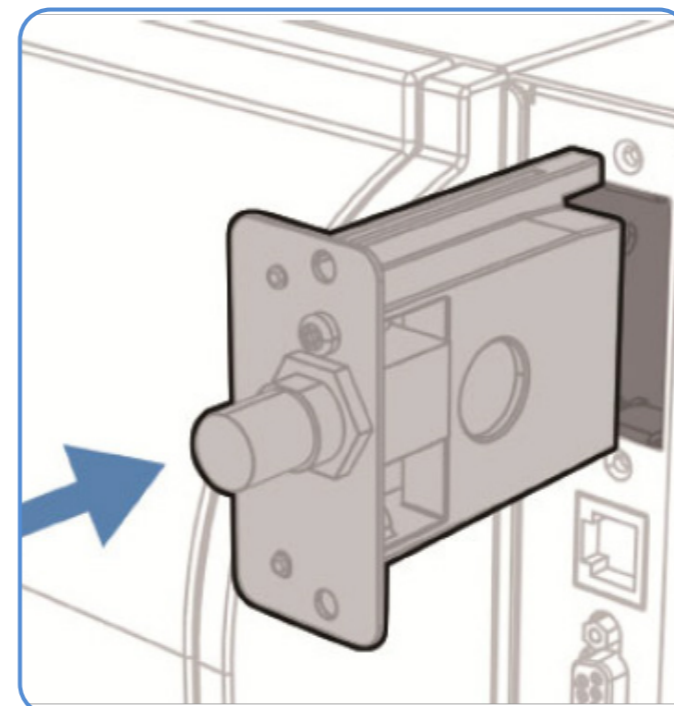

Insert WiFi board

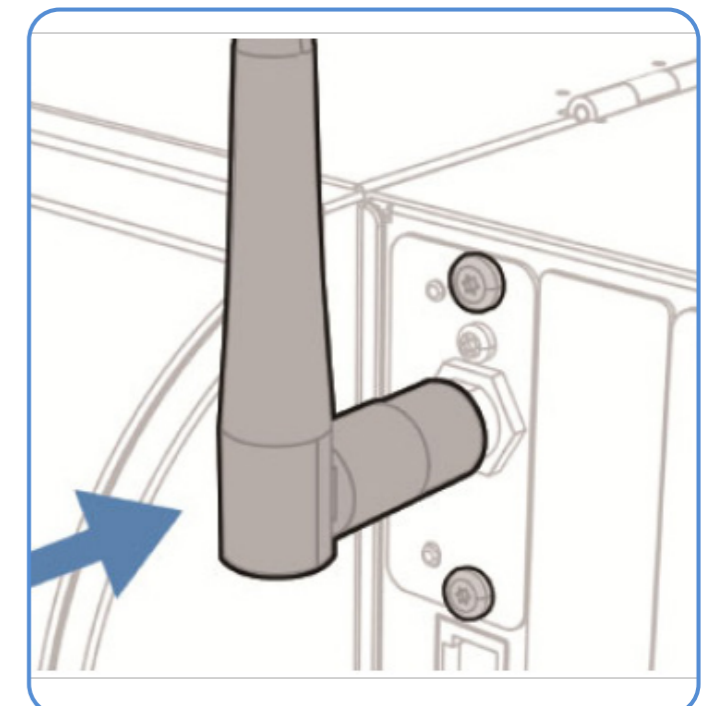

Connect antenna

ACCESSORIES

PD4500C/ PD45S - Cutter

In cut-off printing, each label is automatically cut from the media roll immediately after the label is printed.

You can print on non-adhesive, continuous label stock, and also self-adhesive labels with a liner.

Warning: The Cutters must only be installed by an authorized service technician, as you need to open the printer and physically install the cards in the printer.



	PART NUMBER	DESCRIPTION
1	50178579-001	Cutter Kit for PX240S/ PD45S / PD4500C

ACCESSORIES

Consumables and Cables



PART NUMBER	MODEL	DESCRIPTION
50178577-001	PD45	KIT, PRINTHEAD 203DPI PX240/PD45
50178578-001	PD45	KIT, PRINTHEAD 300DPI PX240/PD45
50177476-001	PD45S	KIT, PRINTHEAD 203 DPI PX240S/PD45S
50178575-001	PD45S	KIT, PRINTHEAD 300DPI PX240S/PD45S



PART NUMBER	DESCRIPTION
50178576-001	Kit, PD45/PD45S Platen Roller



PART NUMBER	DESCRIPTION
321-576-004	USB (USB-A to USB-B) cable, 6.5 ft. (2 m) length



PART NUMBER	DESCRIPTION
1-974022-018	Parallel (IEEE 1284) cable, 5.9 ft. (1.8 m) length



PART NUMBER	DESCRIPTION
1-974024-018	RS-232 (DB9F to DB9M) cable, 5.9 ft. (1.8 m) length



PART NUMBER	DESCRIPTION
1-110501-00	Cleaning Card, 4.5"x6", box of 25

MISCELLANEOUS

AC Cords

Regional Power Cords



PD45 / PD45S Rear I/O View



AC Power - C13 Type Connector

PART NUMBER	TYPE	DESCRIPTION
50117501-001	C13	POWER CORD AUSTRALIA 2500MM,SLED CB
321-501-002	C13	AC Power Cord, Denmark RoHS
77900508E	C13	Cable: power cord, straight, Power cord, Europe EU, IEC320-C13, 2.5 m (8.2 ft)
50131491-001	C13	Cable: power cord, straight - Power cord, India, 1.5 m (5.0 ft)
321-500-002	C13	AC Power Cord, Japan RoHS
9000093CABLE	C13	AC POWER CABLE, C14 TYPE, SWITZERLAND 3-PIN
77900507E	C13	Cable: power cord, straight - Power cord, UK, IEC320-C13, 2.5 m (8.2 ft)
77900506E	C13	Cable: power cord, straight - Power cord, USA, 1.8 m (6.0 ft)

MISCELLANEOUS

Disclaimer

Disclaimer

Honeywell International Inc. ("HII") reserves the right to make changes in specification and other information contained in this document without prior notice, and the reader should in all cases consult HII to determine whether any such changes have been made. The information in this publication does not represent a commitment on the part of HII.

HII shall not be liable for technical or editorial errors or omissions contained herein; nor for incidental or consequential damages resulting the furnishing, performance, or use of this material.

This document contains proprietary information that is protected by copyright. All rights are reserved. No part of this document may be photocopied, reproduced, or translated into another language with-out prior written consent of HII.

Web Address: www.honeywellaidc.com

The Bluetooth trademarks are owned by Bluetooth SIG, Inc., U.S.A and licensed to Honeywell.

Other product names mentioned in the manual may be trademarks of registered trademarks of their respective companies and are the property of their respective owners.

All rights reserved.

For more information

sps.honeywell.com

Honeywell Safety and Productivity Solutions

300 S Tryon St Suite 500
Charlotte, NC 28202
800-582-4263
www.honeywell.com